

FINITURE E COLORI  
FINISHES AND COLORS  
OBERFLÄCHEN UND FARBEN  
ACABADOS Y COLORES **02**



PIEDI IN METALLO  
METAL FEET  
METALLFÜSSE  
PATAS METALLICAS **08**



PIEDI IN LEGNO  
WOODEN FEET  
HOLZFÜSSE  
PATAS DE MADERA **38**



PIEDI IN PLASTICA  
PLASTIC FEET  
PLASTIKFÜSSE  
PATAS DE PLASTICO **50**

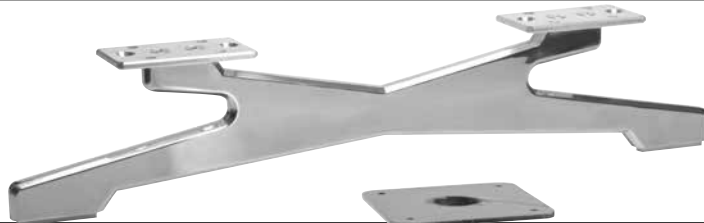

BASAMENTI E TELAI  
BASES AND FRAMES  
BASEN UND RAHMEN  
BASES Y ESTRUCTURAS **56**



BASI GIREVOLI  
REVOLVING BASES  
REVOLVIERENDE BASEN  
BASES GIRATORIAS **60**



RUOTE  
WHEELS  
RAD  
RUEDAS **64**



ACCESSORI  
FITTING  
ZUBEHÖRE  
COMPLEMENTOS **75**

## Fasce di prodotto

Range of products / Sortiment / Categorias de productos



### TOP

Design e finiture top  
Top design and finishing  
Top Design und Ausführungen  
Diseño y acabados de alta gama



### CLASSIC

Classici di sempre  
All time classics  
Aller Zeiten Klassiker  
Clasicos de toda la vida



### BASIC

Economici di qualità  
Quality at low price  
Ökonomische Qualität  
Economicos de calidad

## Materiali

Materials / Materialien / Materiales

<b>AL</b> Alluminio Aluminium Aluminium Aluminio	<b>FE</b> Ferro Iron Eisen Hierro	<b>AI</b> Acciaio inox Stainless steel Edler Stahl Acero inoxidable	<b>OT</b> Ottone Brass Messing Latom	<b>LE</b> Legno Wood Holz Madera	<b>PL</b> Plastica Plastic Plastikfüße Plastico
---	--	--	---	---	--



### PACK

Confezione  
Pack  
Paket  
Confeccion



### PERNI

Su richiesta perni in 8ma o 5/16"  
On request screw with 8ma or 5/16" thread  
Schraube, verfügbar auf Wunsch mit 8ma oder 5/16" gewinde  
Tornillo disponible con rosca 8ma o 5/16"



### PORTATA

Portata  
Load  
Tragfähigkeit  
Capacidad de carga



### GIREVOLE

Girevole  
Revolving  
Drehbar  
Giratoria



### ANTISCIVOLO

Antiscivolo  
Antislip  
Gleitschutz  
Antideslizante

## Cartella finiture su richiesta per piedi e basi in metallo

Finishing chart on request for metal feet and bases  
Farbkarte der Ausführungen auf Anfrage für Metallfüße und Basen  
Tabla de acabados a pedido para pies y bases de metal



GA-NN • Nickel nero  
galvanica  
black nickel, galvanic

GA-OL • Oro lucido  
galvanica  
shiny gold, galvanic

GA-OV • Oro vecchio  
galvanica  
old gold, galvanic

GA-OR • Oro rosa  
galvanica  
red gold, galvanic

VL-NT • Nero titanio  
verniciato liquido  
black titanium, liquid painted

VL-LNT • Nero titanio chiaro  
verniciato liquido  
light black titanium, liquid painted

Tutti i piedi, basamenti e basi in metallo sono producibili (previa verifica) nelle finiture a richiesta con minimo ordine da concordare. Per ragioni grafiche, le finiture riprodotte sono puramente indicative.

All the metal feet and bases can be produced (after checking) on requested finishing with a minimum order quantity to be agreed. For printing reasons the finishings reproduced are only indicative.

Alle Metallfüße und Basen sind (nach Überprüfung) in den gewünschten Ausführungen mit einer zu vereinbarenden Mindestbestellmenge lieferbar. Aus Druckgründen sind die reproduzierten Oberflächen nur Richtwerte.

Todas las patas, bases y basamentos de metal se pueden producir en los acabados bajo solicitados con un pedido mínimo a concretar. Por motivos gráficos, los acabados reproducidos son puramente indicativos.

## Cartella colori per piedi e basi in metallo verniciati a polvere

### Color chart for powder painted metal feet and bases



VP-01 • Bianco  
opaco gofrato - white, rough matt



VP-13L • Crema  
opaco liscio - cream, smooth matt



VP-70L • Argento dorato  
opaco liscio - golden silver, smooth matt



VP-128L • Prosecco  
opaco liscio - prosecco, smooth matt



VP-30 • Grigio perla  
opaco gofrato - pearl grey, rough matt



VP-15L • Havana  
opaco liscio - havava, smooth matt



VP-75L • Delfino  
opaco liscio - dolphin, smooth matt



VP-35 • Ice  
opaco gofrato - ice, rough matt



VP-103 • Rosa  
opaco gofrato - rose, rough matt



VP-38 • Sahara  
opaco gofrato - sahara, rough matt



VP-11L • Sand  
opaco liscio - sand, smooth matt



VP-17 • Topo  
opaco gofrato - mouse, rough matt



VP-95 • Terra  
opaco gofrato - land, rough matt



VP-25 • Rhum  
opaco gofrato - rhum, rough matt



VP-92 • Bronzo antico  
opaco gofrato - old bronze, rough matt



VP-90L • Bronzo scuro  
opaco liscio - dark bronze, smooth matt



VP-76L • Oyster  
opaco liscio - oyster, smooth matt



VP-78 • Cappuccino  
opaco gofrato - cappuccino, rough matt



VP-12 • Talpa  
opaco gofrato - taupe, rough matt



VP-62 • Bruno Sable  
opaco gofrato - brown sablé, rough matt



VP-41L • Stone  
opaco liscio - stone, smooth matt



VP-61L • Manganese Tiger  
opaco liscio - manganese tiger, smooth matt



VP-60L • Manganese  
opaco liscio - manganese, smooth matt



VP-80L • Antracite  
opaco liscio - anthracite, smooth matt



VP-20 • Moka  
opaco gofrato - moka, rough matt



VP-20L • Moka  
opaco liscio - moka, smooth matt



VP-20LL • Moka  
lucido liscio - moka, smooth polished



VP-93LL • Bronzo lucido  
lucido liscio - polish bronze, smooth polished

## Farbkarte für pulverbeschichtete Metallfüße und Basen

### Tabla de colores de pinturas en polvo para pies y bases metálicas



VP-21L • Cacao  
opaco liscio - cacao, smooth matt



VP-31L • Lavagna  
opaco liscio - blackboard, smooth matt



VP-50L • Nero  
opaco liscio - black, smooth matt



VP-50 • Nero  
opaco gofrato - black, rough matt



VP-10 • Mastice  
opaco gofrato - mastic, rough matt



VP-40 • Grafite  
opaco gofrato - graphite, rough matt



VP-32L • Ardesia  
opaco liscio - slate, smooth matt

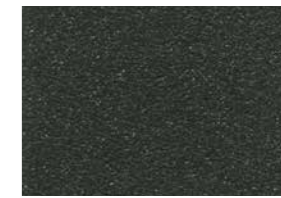

VP-33 • Cemento  
opaco gofrato - cement, rough matt



VP-117 • Avio  
opaco gofrato - avio, rough matt



VP-115 • Marine  
opaco gofrato - marine, rough matt



VP-113 • River  
opaco gofrato - river, rough matt



VP-110L • Blu  
opaco liscio - blue, smooth matt



VP-130 • Musk  
opaco gofrato - musk, rough matt



VP-132 • Foresta  
opaco gofrato - forest, rough matt



VP-48L • Antique  
opaco liscio - antique smooth matt

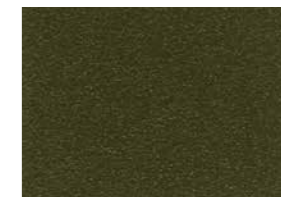

VP-134 • Country  
opaco gofrato - country, rough matt



VP-120L • Oro  
opaco liscio - gold, smooth matt



VP-124 • India  
opaco gofrato - india, rough matt



VP-127L • Arabia  
opaco liscio - arabia, smooth matt



VP-85L • Sequoia  
opaco liscio - sequoia, smooth matt



VP-101L • Rosso  
opaco liscio - red, smooth matt



VP-100L • Burgundy  
opaco liscio - burgundy, smooth matt

Tutti i piedi, basamenti e basi in metallo possono essere verniciati a polvere con ordine minimo una confezione per colore. Per ragioni grafiche, i colori riprodotti sono puramente indicativi.

All the metal feet and bases can be powder painted with a minimum order of one pack for color. For printing reasons the colors reproduced are only indicative.

Alle Metallfüße und Basen können mit einer Mindestbestellmenge von einer Packung für Farbe pulverbeschichtet werden. Aus Druckgründen sind die reproduzierten Farben nur Richtwerte.

Todas las patas, bases y basamentos de metal se pueden barnizar en polvo con un pedido mínimo es una caja. Por motivos gráficos, los acabados reproducidos son puramente indicativos.

articolo/item	pagina/page	articolo/item	pagina/page	articolo/item	pagina/page	articolo/item	pagina/page
031-085	55	bunny	19	fire	18	lq 105	44
11	45	bunny 1	19	flauto	42	lqg 100	44
117	55	bussole ferro	76	fleming	12	lr	55
12	45	buster	16	floor	53	luna	46
1472	10	calais	61	fogo	38	luna base	63
170	8	call	34	fondelli 3 fori	76	luxor	17
2225	61	cambridge	47	fondelli ragno	76	m159	43
608	30	cargo	71	fox	21	madison	39
9010	30	carlo	60	free	21	magic	20
9011	30	casinò	61	full	33	magic base	60
9011 ferro	30	castello	10	funny	33	malibù	26
a11 con tappo	56	cayman	30	fusion	15	margot	49
a55	54	centrale 1	9	garden	39	margot base	58
a60	54	cester	43	garria	46	margot 1	58
acquamarina	9	cilindrico	42	gemellata	71	marTE	40
acquamarina base	9	cipolla	43	gemma	27	martin	58
adi	25	cippendale	43	genova	26	marvin	58
admiral	17	cobalto	14	george	24	mary	59
adriatico	29	conico	42	georgia	53	maschera	26
agata	41	conico con incavo	42	giulio dritto	44	master	26
albatros	37	conico con ruota	42	giulio inclinato	44	maui	18
alcea	51	cono	62	goal	23	maxi jim	24
ancora	66	cool	11	graffiti 1	32	mediterraneo	37
angelo	22	corallo	31	ho3	64	melvin	34
angelo centrale	22	crazy	20	hades	32	messico	33
angelo ferro	22	cross 4 razze	64	hermes	32	meta	25
angi	22	cross 5 razze	64	honolulu	48	mezza sfera	8
angolare	57	cuba	18	houston	52	miami	12
aramis	34	cuba legno	49	ibis	14	miami legno	47
arca	27	curo	36	industriali	72	milano	31
arcangelo	22	d1	55	infinity	17	millerighe	76
arco	36	dakar	51	italo	38	mini	50
arpione	67	dallas	46	jo1	62	minimal	11
astico	15	degas	41	jo8	62	molly 1	25
athos	34	diana	60	jardin	39	monterey	50
b3	9	disco zigrinato	76	jazz	24	mv100	8
baltico	20	distanziali	76	jersey	52	mv300	8
bamboo	46	doppia	71	jim	24	mv350	8
barocco	43	duke	16	k autobloccante	56	nave	14
bello	14	dune	15	las vegas	49	navy	67
bicchiere	74	durer	16	lecce	48	neutrone	27
bicchiera antigraffio	76	easy	54	leuca	48	nevada	47
bicchiera quadro	74	elica	67	lh	55	new york	59
big george	10	empty	28	lift	12	nexus	35
big jim	24	enea	45	lince	20	nick	59
bixite	14	est	52	lombardia	65	nico	10
blitz	70	feltro adesivo	76	long island	26	nico 4 razze	63
bloom	20	fiona	27	los angeles	49	nico 5 razze	63
buffalo	49	fionda	28	lq	44	noè	27

articolo/item	pagina/page	articolo/item	pagina/page	articolo/item	pagina/page
o-ring	74	riviera	9	tato	50
oakland	49	rodin	41	tatoo	17
obliquo	45	rog	73	tdf	28
ocean	37	rom	73	teseo	32
odin	40	roma	31	texas	19
ontario	48	roma ferro	31	tilt 1	29
orlando	45	romagna	65	tilt 2	29
orlanto	51	romagna alta	65	tilt 3	29
p120	56	rondella zincata	75	tilt alluminio	29
paddock	28	rondine	50	timone	66
pagoda	35	rop	73	titano	46
palm 1	25	rq	74	tito	12
panama	18	rsa 10	68	titone	12
panca	59	rsa 12	68	tivoli	36
paride	33	rsa 13	68	tm	57
park	39	rsa 18	69	togo	50
piastra fast	75	rsa 22	69	top	23
piastra tum	75	rubino	21	toy	23
piattelli	75	s140	56	trucco	32
piattello antiscivolo	76	s200	56	tube	70
piattello mobile	75	s220 con ruota	56	tucson	51
piattello pa	75	salento	47	valle	40
piattello pb	75	samba	41	vasco	18
piede per chiodo	57	santana	47	venecia	37
pivoettante	71	sesto	38	veneto	65
plat	62	shelly	25	venus	39
pm233	35	silvan	19	vintage	11
pm244	35	silvan base	60	vintage inclinato	11
pm530	35	silvan centrale	19	vite legno	57
pm563	15	sky	66	vite legno a60	57
pmf	61	sm3	55	vuzero	40
pongo	63	smeraldo	21	west	52
pop	17	smeraldo ferro	21	winter	16
porthos	34	smile	23	winter ferro	16
pps	38	smile 2	23	x01	13
pqw	54	spacer	28	x02	13
presidente	15	speedy	51	x03	13
pressione	57	spillo	55	x04	13
pretty	73	star	66	x05	13
puntale wood	76	stella	10	yang	70
puntali	77	stendhal	43	yin	70
qua	53	stoccarda	31	z1	57
qui	53	sud	52	zeus	40
r169n	56	swan	37	zoe	36
ragno	64	swing 1	11	zotta	36
regolo	56	swivel	67		
rettangolare	57	tabù	38		
rettangolo	53	tacos	45		
rikota	41	talos	33		

Ordine minimo per articolo una confezione, salvo disponibilità a magazzino e/o esigenze produttive.

Minimum order for each article is one pack, subject to stock availability or production needs.

Wenn nicht im Lager oder wegen technischen Beduerfnissen, minimale Menge pro Artikel ist eine Verpackung.

Pedido mínimo una confezione por artículo salvo stock almacén y/o exigencias de producción.

### mezza sfera

AL

Art	H mm	Finitura/Finishing
20A MS L40	40	lucido/polished
20A MS O40	40	opaco/mat

72

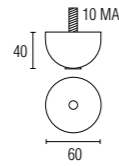
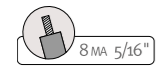

### mv100

AL

Art	H mm	Finitura/Finishing
20A 10 L6010040	100	lucido/polished
20A 10 O6010040	100	opaco/mat
20A 10 L6012040	120	lucido/polished
20A 10 O6012040	120	opaco/mat
20A 10 L6016040	160	lucido/polished
20A 10 O6016040	160	opaco/mat
20A 10 L6018040	180	lucido/polished
20A 10 O6018040	180	opaco/mat

48

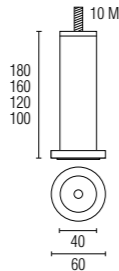
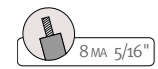

### mv300

AL

Art	H mm	Finitura/Finishing
20A 30 L4008040	80	lucido/polished
20A 30 O4008040	80	opaco/mat
20A 30 L4010040	100	lucido/polished
20A 30 O4010040	100	opaco/mat
20A 30 L4012040	120	lucido/polished
20A 30 O4012040	120	opaco/mat
20A 30 L4015040	150	lucido/polished
20A 30 O4015040	150	opaco/mat

48

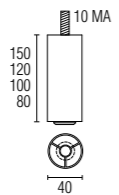
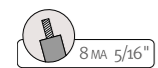

### mv350

AL

Art	H mm	Finitura/Finishing
20A 35 L6008040	80	lucido/polished
20A 35 O6008040	80	opaco/mat
20A 35 L6010040	100	lucido/polished
20A 35 O6010040	100	opaco/mat
20A 35 L6012040	120	lucido/polished
20A 35 O6012040	120	opaco/mat
20A 35 L6015040	150	lucido/polished
20A 35 O6015040	150	opaco/mat

48

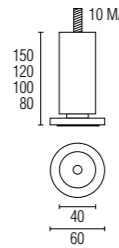
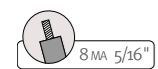

### 170

FE

Art	H mm	Finitura/Finishing
20F 170 C100R	100	cromato/chromed
20F 170 C120R	120	cromato/chromed
20F 170 C150R	150	cromato/chromed

64

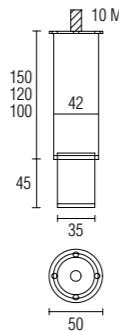

Regolabile  
adjustable  
verstellbar  
regulable

### centrale 1

FE

Art	H mm	Finitura/Finishing
20F CEN1 C100Z	100	cromato/chromed
30F CEN1 VP100Z/50L	100	VP-50L nero/black
20F CEN1 C110Z	110	cromato/chromed
20F CEN1 C115Z	115	cromato/chromed
20F CEN1 C120Z	120	cromato/chromed
20F CEN1 C130Z	130	cromato/chromed
30F CEN1 VP130Z/50L	130	VP-50L nero/black

48

Art	H mm	Finitura/Finishing
20F CEN1 C135Z	135	cromato/chromed
20F CEN1 C140Z	140	cromato/chromed
30F CEN1 VP140Z/50L	140	VP-50L nero/black
20F CEN1 C150Z	150	cromato/chromed
30F CEN1 VP150Z/50L	150	VP-50L nero/black
20F CEN1 C160Z	160	cromato/chromed
30F CEN1 VP160Z/50L	160	VP-50L nero/black

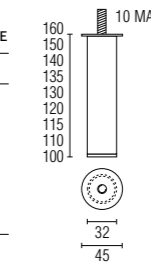

### acquamarina

FE

Art	H mm	Finitura/Finishing
20F ACQ C45070Z	70	cromato/chromed
20F ACQ C45100Z	100	cromato/chromed
20F ACQ C45120Z	120	cromato/chromed
20F ACQ C45130Z	130	cromato/chromed

48

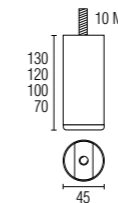

### acquamarina base

FE

Art	H mm	Finitura/Finishing
20F ACB C45100Z	100	cromato/chromed
20F ACB C45120Z	120	cromato/chromed
20F ACB C45150Z	150	cromato/chromed

48

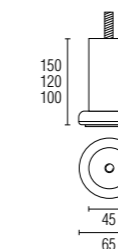

### riviera

AL

Art	H mm	Finitura/Finishing
20A RIV L50100	100	lucido/polished
20A RIV O50100	100	opaco/mat
20A RIV L50130	130	lucido/polished
20A RIV O50130	130	opaco/mat

48

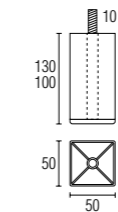

### b3

AL

Art	H mm	Finitura/Finishing
20A B3 LULU100	100	lucido/polished
20A B3 OPOP100	100	opaco/mat
20A B3 LULU120	120	lucido/polished
20A B3 OPOP120	120	opaco/mat
20A B3 LULU140	140	lucido/polished
20A B3 OPOP140	140	opaco/mat

24

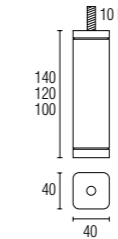

### 1472

● AL

Art	H mm	Finitura/Finishing
20A 1472 L120	120	lucido/polished
20A 1472 O120	120	opaco/mat

☞ 48

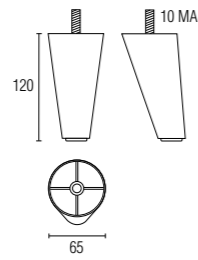
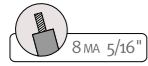

### castello

● AL

Art	H mm	Finitura/Finishing
20A CAS L080S	80	lucido/polished
20A CAS O080S	80	opaco/mat

☞ 48

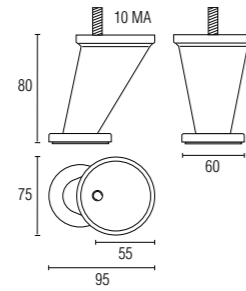

### nico

● AL

Art	H mm	Finitura/Finishing
20A NIC L120	120	lucido/polished
20A NIC O120	120	opaco/mat

☞ 48

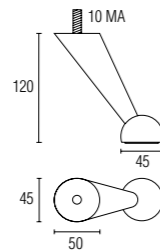
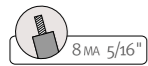

### stella

● AL

Art	H mm	Finitura/Finishing
20A STEL L130S	130	lucido/polished
20A STEL O130S	130	opaco/mat
20A STEL L160	160	lucido/polished
20A STEL O160	160	opaco/mat

☞ 24

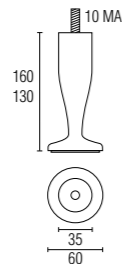

### big george

● AL

Art	H mm	Finitura/Finishing
20A 2013 L145S	145	lucido/polished
20A 2013 O145S	145	opaco/mat
20A 2013 L170S	170	lucido/polished
20A 2013 O170S	170	opaco/mat

☞ 24

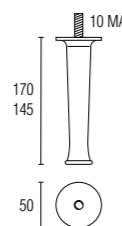

### swing 1

● FE

Art	H mm	Finitura/Finishing
20F SW11 C150Z	150	cromato/chromed
30F SW11 VP150Z/50L	150	VP-50L nero/black
20F SW11 C170Z	170	cromato/chromed
30F SW11 VP170Z/50L	170	VP-50L nero/black

☞ 48

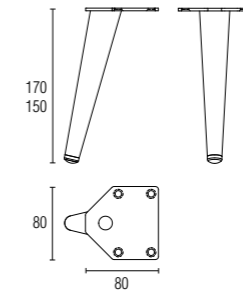

new entry

### vintage

● FE

Art	H mm	Finitura/Finishing
20F VIND CR350S	350	cromato/chromed

☞ 48

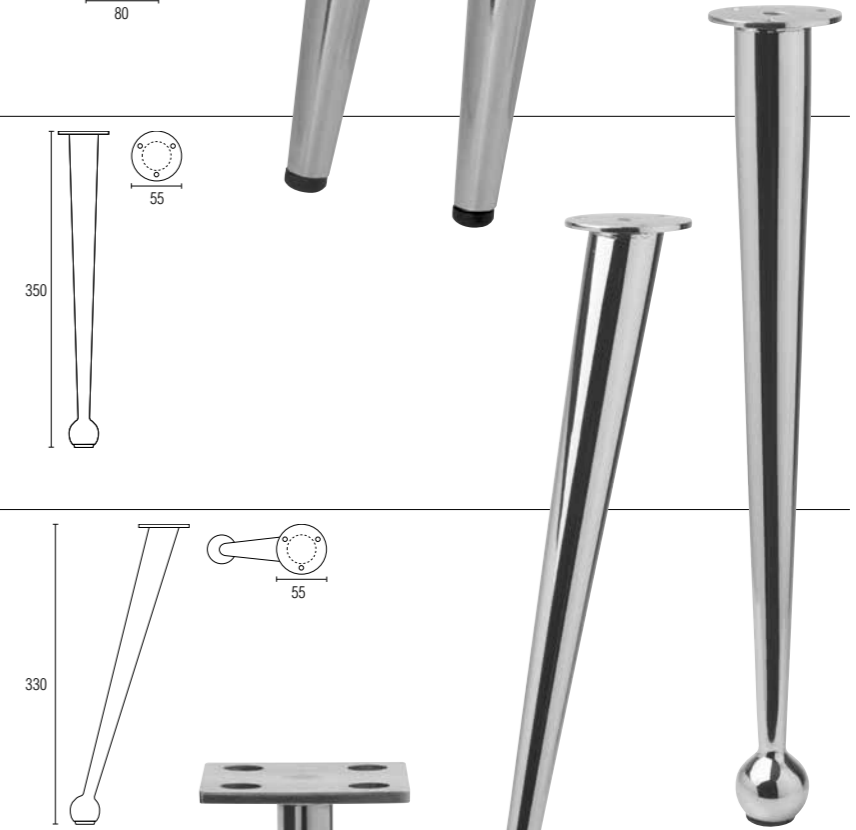
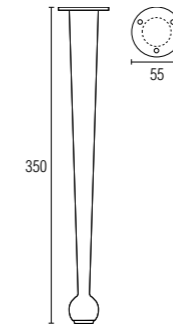

### vintage inclinato

● FE

Art	H mm	Finitura/Finishing
20F VINI CR330S	330	cromato/chromed

☞ 48

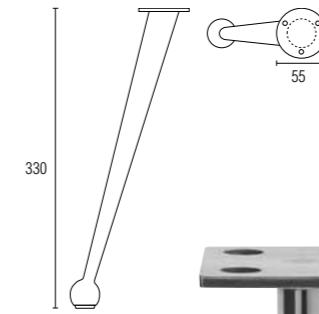

### minimal

● AL

Art	H mm	Finitura/Finishing
20F MIN L190S	190	lucido/polished

☞ 48

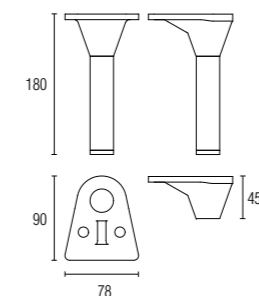

### cool

● AL

Art	H mm	Finitura/Finishing
20A COO GA180S-NN	180	GA-NN nickel nero/black nickel + VP-50L nero/black
20A COO GA045S-NN	45	GA-NN nickel nero/black nickel

☞ 48

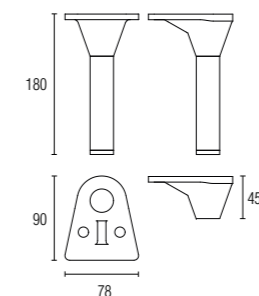

new entry

20A COO GA045S-NN

Capitello fornito con viti e puntale  
Article supplied with screws and tip  
Artikel mit Schrauben geliefert  
Artículo suministrado con tornillos

### miami

● AL

Art	H mm	Finitura/Finishing
20A MIA L180S	180	lucido/polished
20A MIA O180S	180	opaco/mat

☞ 24

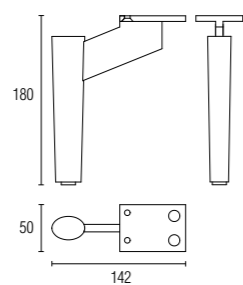

new entry

### fleming

● FE

Art	H mm	Finitura/Finishing
20F FLE C180Z	180	cromato/chromed
30F FLE VP180Z/50L	180	VP-50L nero/black

☞ 48

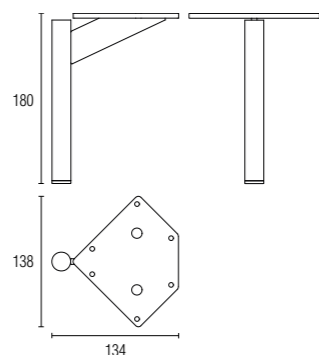

new entry

### lift

● FE

Art	H mm	Finitura/Finishing
20F LIF C085S	85	cromato/chromed

☞ 48

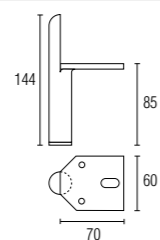

### tito

● FE

Art	H mm	Finitura/Finishing
20F TIT C120S	120	cromato/chromed
20F TIT VL120S-NT	120	VL-NT nero titanio/black titanium
30F TIT VP120S-50L	120	VP-50L nero/black

☞ 24

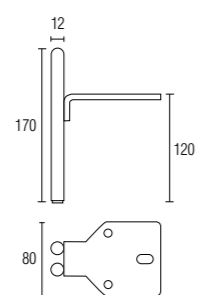

new entry

### titone

● FE

Art	H mm	Finitura/Finishing
20F TITO C150S	150	cromato/chromed
20F TITO VL150S-NT	150	VL-NT nero titanio/black titanium
20F TITO C170S	170	cromato/chromed
20F TITO VL170S-NT	170	VL-NT nero titanio/black titanium

☞ 24

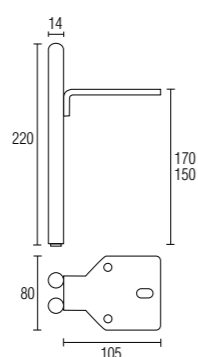

new entry

### X01

● FE

Art	H mm	Finitura/Finishing
20F X01 C125T	125	cromato/chromed

☞ 8

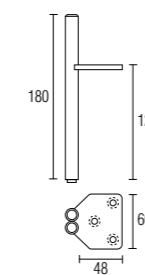

new entry

### X02

● FE

Art	H mm	Finitura/Finishing
20F X02 C145T	145	cromato/chromed

☞ 8

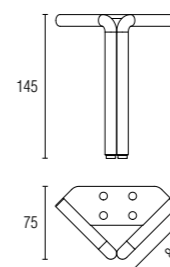

new entry

### X03

● FE

Art	H mm	Finitura/Finishing
20F X03 C150T	150	cromato/chromed

☞ 8

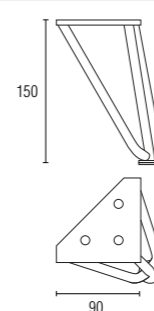

new entry

### X04

● FE

Art	H mm	Finitura/Finishing
20F X04 C140T	140	cromato/chromed

☞ 4

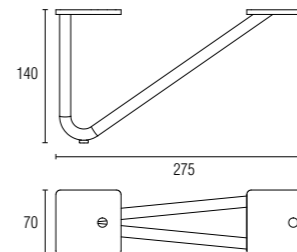

new entry

### X05

● FE

Art	H mm	Finitura/Finishing
20F X05 C145T	145	cromato/chromed

☞ 4

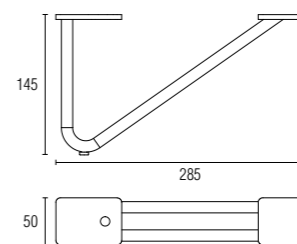

new entry

### nave

● AL

Art	H mm	Finitura/Finishing
20A NAV L80S	80	lucido/polished
20A NAV O80S	80	opaco/mat
20A NAV L100S	100	lucido/polished
20A NAV O100S	100	opaco/mat

☞ 24

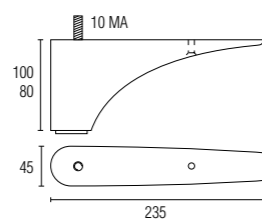

### ibis

● AL

Art	H mm	Finitura/Finishing
20A IBI L120S	120	lucido/polished
20A IBI O120S	120	opaco/mat
20A IBI L150S	150	lucido/polished
20A IBI O150S	150	opaco/mat

☞ 48

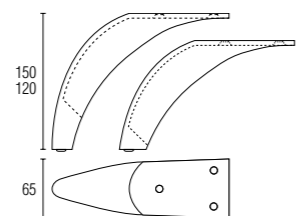

### bello

● AL

Art	H mm	Finitura/Finishing
20A BEL L130S	130	lucido/polished
20A BEL O130S	130	opaco/mat
20A BEL L160S	160	lucido/polished
20A BEL O160S	160	opaco/mat

☞ 24

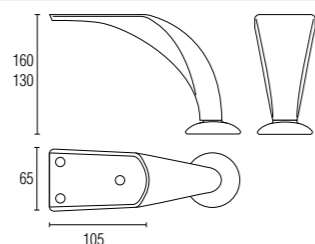

### bixite

● FE

Art	H mm	Finitura/Finishing
20F BIX C080Z	80	cromato/chromed

☞ 48

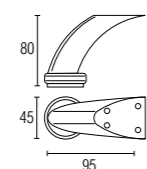

### cobalto

● FE

Art	H mm	Finitura/Finishing
20F COB C120Z	120	cromato/chromed

☞ 24

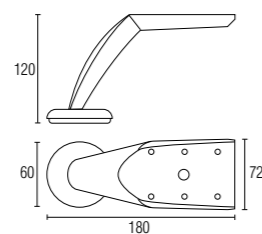

### presidente

● AL

Art	H mm	Destro Right	Sinistro Left	Finitura/Finishing
20A 2137 L140D	140	•		lucido/polished
20A 2137 L140S	140		•	lucido/polished
20A 2137 O140D	140	•		opaco/mat
20A 2137 O140S	140		•	opaco/mat

☞ 12

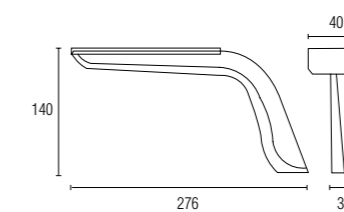

### dune

● AL

Art	H mm	Finitura/Finishing
20A M176 L140S	140	lucido/polished
20A M176 O140S	140	opaco/mat

☞ 24

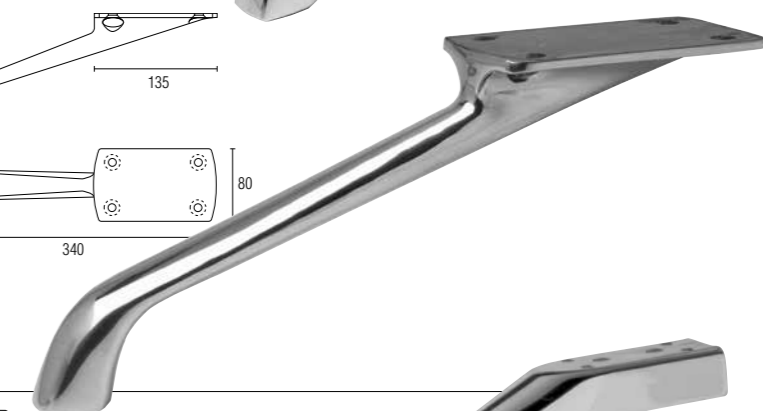
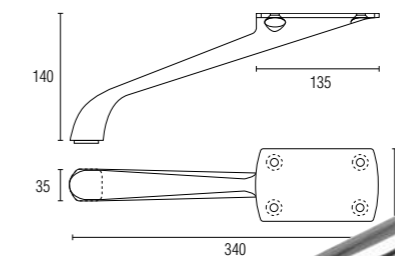

### astico

● FE

Art	H mm	Finitura/Finishing
20F AST C118Z	118	cromato/chromed
20F AST1 C118Z	122	cromato/chromed
20F AST1 GA118Z-NN	122	GA-NN nickel nero/black nickel

☞ 24

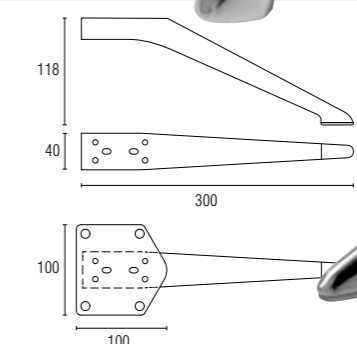

20F AST C118Z

20F AST1 C118Z

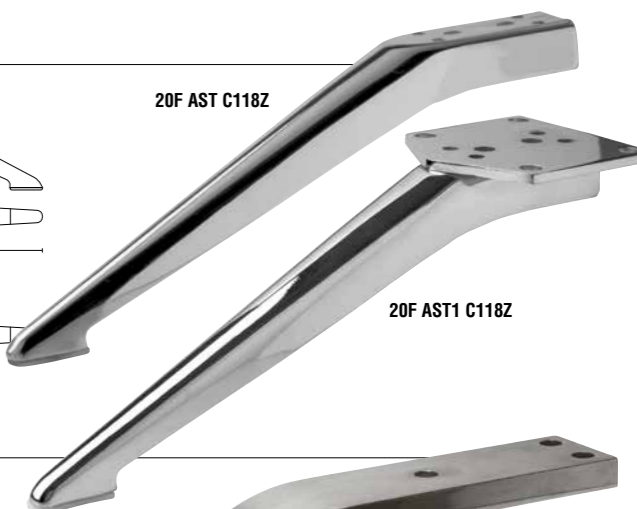

### pm563

● AL

Art	H mm	Finitura/Finishing
20A PM563 L115	120	lucido/polished
20A PM563 O115	120	opaco/mat
20A PM563 L140	135	lucido/polished
20A PM563 O140	135	opaco/mat

☞ 12

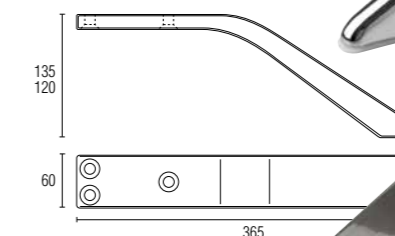

### fusion

● AL

Art	H mm	Finitura/Finishing
20A FUS L200S	200	lucido/polished
20A FUS O200S	200	opaco/mat

☞ 24

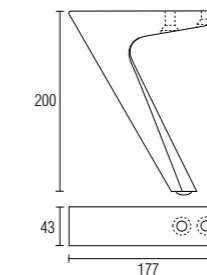

new entry



### duke

● AL

Art	H mm	Finitura/Finishing
20A DUK L085S	85	lucido/polished
20A DUK O085S	85	opaco/mat
20A DUK L145S	145	lucido/polished
20A DUK O145S	145	opaco/mat

☞ 20

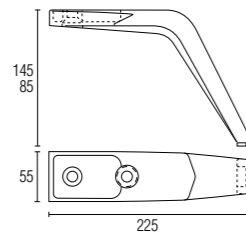

### durer

● AL

Art	H mm	Finitura/Finishing
20A DUR L140S	140	lucido/polished
20A DUR O140S	140	opaco/mat

☞ 24

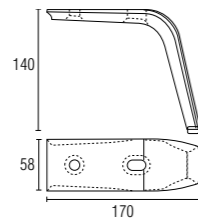

### winter

● AL

Art	H mm	Finitura/Finishing
20A WIN L105S	105	lucido/polished
20A WIN O105S	105	opaco/mat
20A WIN L135S	135	lucido/polished
20A WIN O135S	135	opaco/mat

☞ 24

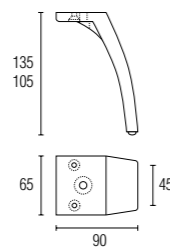

### winter ferro

● FE

Art	H mm	Finitura/Finishing
20F WIN C120Z	120	cromato/chromed

☞ 48

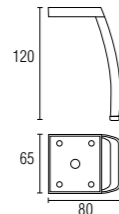

### buster

● FE

Art	H mm	Finitura/Finishing
20F BUS C120Z	120	cromato/chromed
20F BUS C150Z	150	cromato/chromed

☞ 24

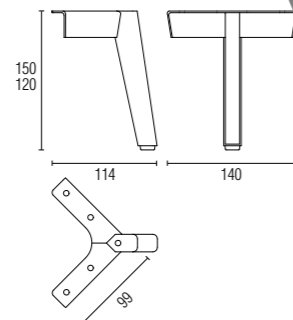

new entry

### pop

● FE

Art	H mm	Finitura/Finishing
20F POP C150S	150	cromato/chromed
20F POP C170S	170	cromato/chromed
20F POP C190S	190	cromato/chromed

☞ 24

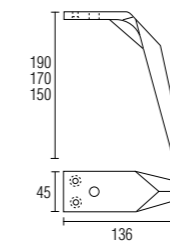

### admiral

● AL

Art	H mm	Finitura/Finishing
20A ADM L180S	180	lucido/polished
20A ADM O180S	180	opaco/mat

☞ 24

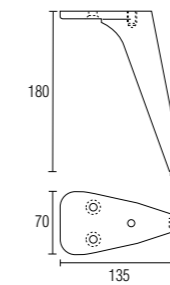

new entry

### luxor

● AL

Art	H mm	Finitura/Finishing
20A LUX L190S	190	lucido/polished
20A LUX O190S	190	opaco/mat
20A LUX VL190S-NT	190	VL-NT nero titanio/black titanium

☞ 24

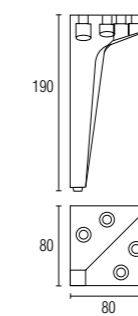

new entry

### tatoo

● AL

Art	H mm	Finitura/Finishing
20A TAT L160S	160	lucido/polished
20A TAT O160S	160	opaco/mat

☞ 24

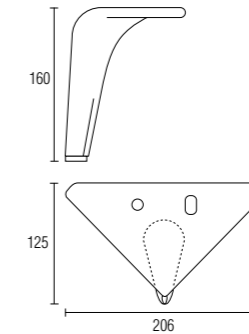

new entry

### infinity

● AL

Art	H mm	Finitura/Finishing
20A INF L180	180	lucido/polished
20A INF O180	180	opaco/mat

☞ 24

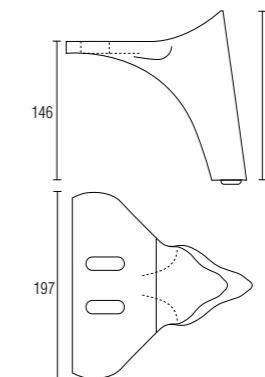

### panama

AL

Art	H mm	Finitura/Finishing
20A PAN L150S	150	lucido/polished
20A PAN VL150S-LNT	150	VL-LNT nero titanio chiaro light black titanium

24

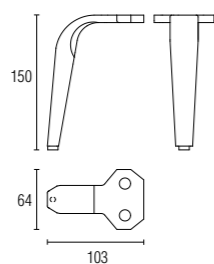

new entry

### maui

AL

Art	H mm	Finitura/Finishing
20A MAU L160S	160	lucido/polished
20A MAU O160S	160	opaco/mat
20A MAU GA160S-NN	160	GA-NN nickel nero/black nickel

24

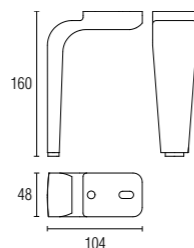

new entry

### vasco

AL

Art	H mm	Finitura/Finishing
20A VAS L160S	160	lucido/polished
20A VAS O160S	160	opaco/mat
20A VAS GA160S-NN	160	GA-NN nickel nero/black nickel

24

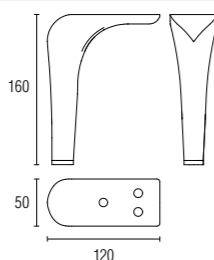

new entry

### cuba

AL

Art	H mm	Finitura/Finishing
20A CUB L160S	160	lucido/polished
20A CUB O160S	160	opaco/mat

24

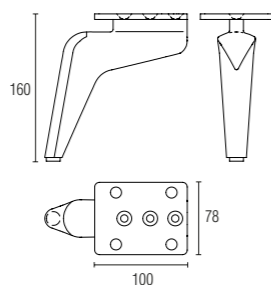

new entry

### fire

FE

Art	H mm	Finitura/Finishing
20F FIR C130Z	130	cromato/chromed
30F FIR VP130Z/50L	130	VP-50L nero/black

48

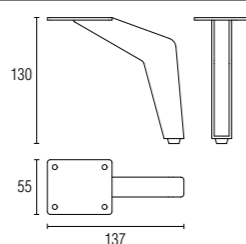

new entry

### bunny

AL

Art	H mm	Finitura/Finishing
20A BUN L170S	170	lucido/polished
20A BUN O170S	170	opaco/mat

24

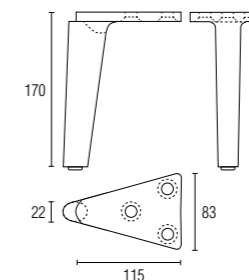

### bunny 1

AL

Art	H mm	Finitura/Finishing
20A BUN1 L170S	170	lucido/polished
20A BUN1 O170S	170	opaco/mat

24

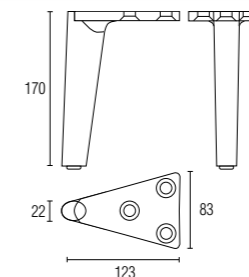

### texas

AL

Art	H mm	Finitura/Finishing
20A TEX L180S	180	lucido/polished
20A TEX O180S	180	opaco/mat

48

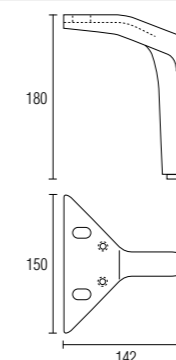

new entry

### silvan

AL

Art	H mm	Finitura/Finishing
20A SIL L200	200	lucido/polished
20A SIL O200	200	opaco/mat

16

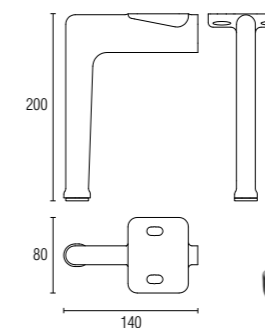

new entry

### silvan centrale

AL

Art	H mm	Finitura/Finishing
20A SIL1 L200	200	lucido/polished
20A SIL1 O200	200	opaco/mat

16

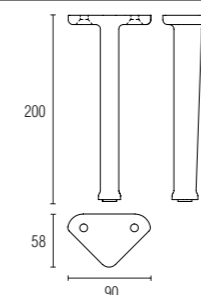

### crazy

● AL

Art	H mm	Finitura/Finishing
20A CRA L130S	130	lucido/polished
20A CRA O130S	130	opaco/mat
20A CRA L160S	160	lucido/polished
20A CRA O160S	160	opaco/mat
20A CRA L190S	190	lucido/polished
20A CRA O190S	190	opaco/mat

☞ 24

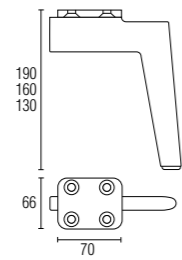

### magic

● AL

Art	H mm	Finitura/Finishing
20A MAG L160	160	lucido/polished
20A MAG O160	160	opaco/mat
20A MAG L190	190	lucido/polished
20A MAG O190	190	opaco/mat

☞ 24

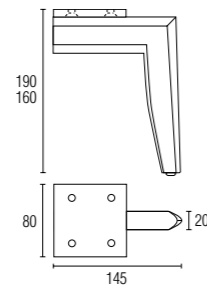

### lince

● FE

Art	H mm	Finitura/Finishing
20F LIN C080T	80	cromato/chromed
20F LIN C120T	120	cromato/chromed
20F LIN C130T	130	cromato/chromed
20F LIN C140T	140	cromato/chromed
20F LIN C150T	150	cromato/chromed

☞ 48

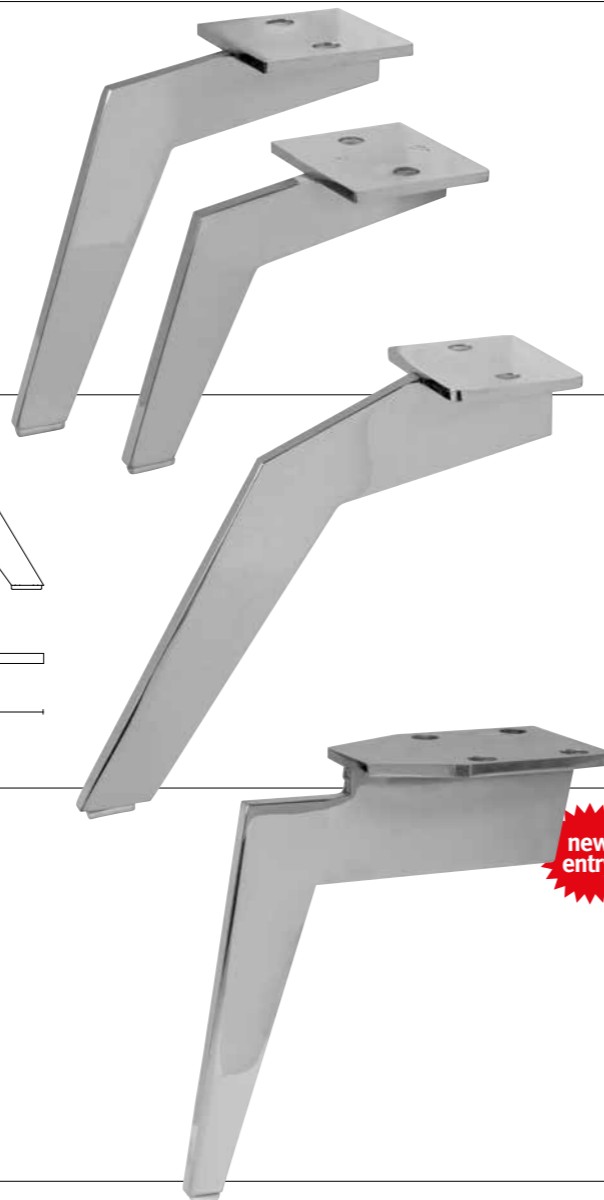
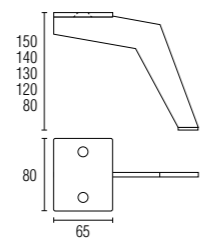

### bloom

● FE

Art	H mm	Finitura/Finishing
20F BLO C180T	180	cromato/chromed

☞ 48

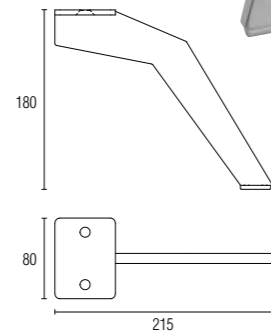

### baltico

● FE

Art	H mm	Finitura/Finishing
20F BAL C170T	170	cromato/chromed

☞ 48

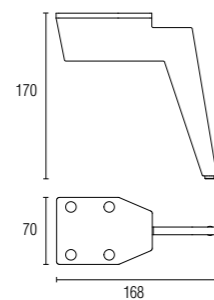

new entry

### smeraldo

● AL

Art	H mm	Finitura/Finishing
20A SME L155S	155	lucido/polished
20A SME O155S	155	opaco/mat

☞ 24

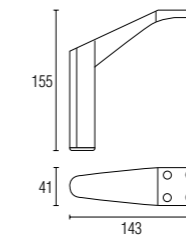

### smeraldo ferro

● FE

Art	H mm	Finitura/Finishing
20F SME C150Z	150	cromato/chromed

☞ 24

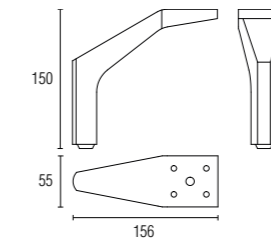

new entry

### fox

● AL

Art	H mm	Finitura/Finishing
20A FOX L140S	140	lucido/polished
20A FOX O140S	140	opaco/mat
20A FOX L160S	160	lucido/polished
20A FOX O160S	160	opaco/mat

☞ 24

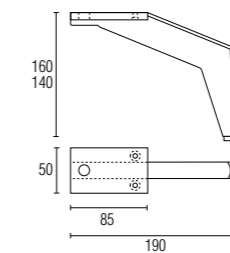

### free

● AL

Art	H mm	Finitura/Finishing
20A FRE L120S	120	lucido/polished
20A FRE O120S	120	opaco/mat

☞ 24

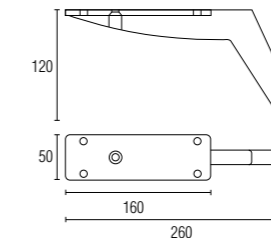

### rubino

● FE

Art	H mm	Finitura/Finishing
20F RUB C150S	150	cromato/chromed

☞ 48

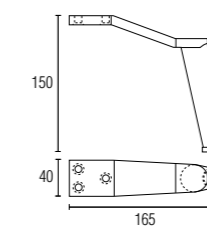

### angi

● AL

Art	H mm	Finitura/Finishing
20A ANGI L160S	160	lucido/polished
20A ANGI O160S	160	opaco/mat
20A ANGI L190S	190	lucido/polished
20A ANGI O190S	190	opaco/mat
20A ANGI L210S	210	lucido/polished
20A ANGI O210S	210	opaco/mat

☞ 24

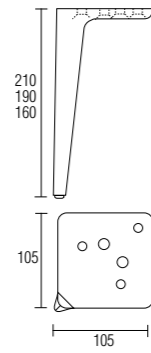

new entry

### angelo

● AL

Art	H mm	Finitura/Finishing
20A ANG L130S	130	lucido/polished
20A ANG O130S	130	opaco/mat
20A ANG L150S	150	lucido/polished
20A ANG O150S	150	opaco/mat
20A ANG L170S	170	lucido/polished
20A ANG O170S	170	opaco/mat

☞ 24

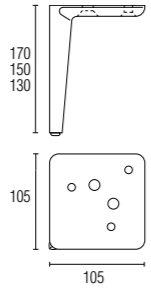

### angelo centrale

● AL

Art	H mm	Finitura/Finishing
20A CEN L130	130	lucido/polished
20A CEN O130	130	opaco/mat
20A CEN L150	150	lucido/polished
20A CEN O150	150	opaco/mat
20A CEN L170	170	lucido/polished
20A CEN O170	170	opaco/mat

☞ 24

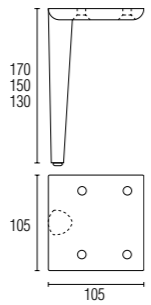

### angelo ferro

● FE

Art	H mm	Finitura/Finishing
20F ANG C130Z	130	cromato/chromed
30F ANG VP130Z/50	130	VP-50 nero/black
20F ANG C150Z	150	cromato/chromed
30F ANG VP150Z/50	150	VP-50 nero/black
20F ANG C170Z	170	cromato/chromed
30F ANG VP170Z/50	170	VP-50 nero/black

☞ 48

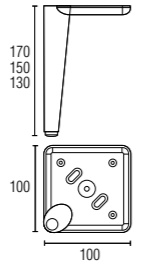

### arcangelo

● FE

Art	H mm	Finitura/Finishing
20F ARC C135S	135	cromato/chromed
20F ARC C155S	155	cromato/chromed

☞ 40

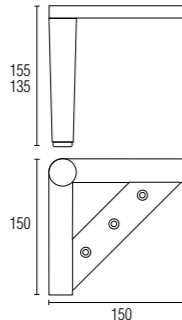

### top

● AL

Art	H mm	Finitura/Finishing
20A TOP L155S	155	lucido/polished
20A TOP O155S	155	opaco/mat
20A TOP VL155S-NT	155	VL-NT nero titanio/black titanium

☞ 24

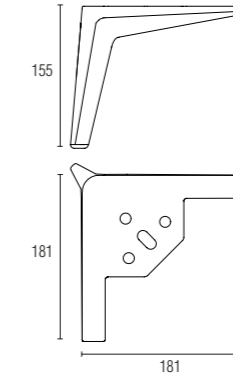

new entry

### toy

● AL

Art	H mm	Finitura/Finishing
20A TOY L140S	140	lucido/polished
20A TOY O140S	140	opaco/mat
20A TOY GA140S-NN	140	GA-NN nickel nero/black nickel

☞ 24

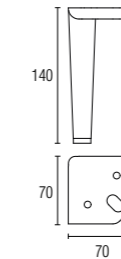

new entry

### smile

● AL

Art	H mm	Finitura/Finishing
20A SMI L115S	115	lucido/polished
20A SMI O115S	115	opaco/mat
20A SMI L145S	145	lucido/polished
20A SMI O145S	145	opaco/mat

☞ 24

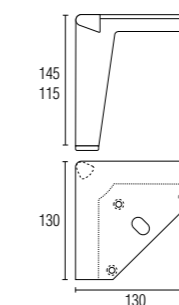

### smile 2

● AL

Art	H mm	Finitura/Finishing
20A SMI2 L175S	175	lucido/polished
20A SMI2 O175S	175	opaco/mat

☞ 24

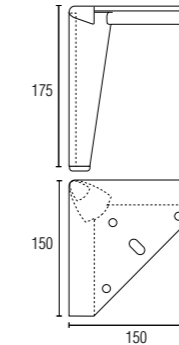

### goal

● AL

Art	H mm	Finitura/Finishing
20A GOA L145S	145	lucido/polished
20A GOA O145S	145	opaco/mat

☞ 24

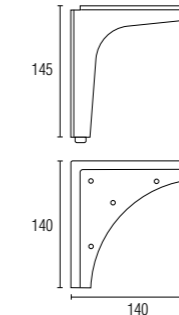

### george

● FE

Art	H mm	Finitura/Finishing
20F GEO C160Z	160	cromato/chromed

☞ 24

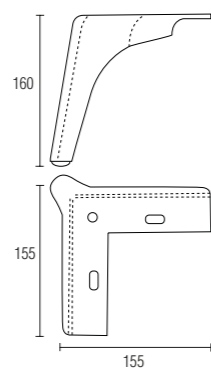

new entry

### jazz

● FE

Art	H mm	Finitura/Finishing
20F JAZ1 C135Z	135	cromato/chromed
20F JAZ1 GA135Z-NN	135	GA-NN nickel nero-black nickel
30F JAZ1 VP135Z/20L	135	VP-20L moka
30F JAZ1 VP135Z/50L	135	VP-50L nero/black

☞ 24

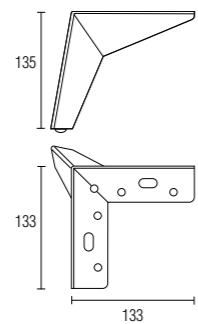

### jim

● FE

Art	H mm	Finitura/Finishing
20F JIM C130Z	130	cromato/chromed

☞ 24

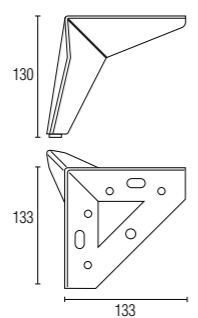

### big jim

● FE

Art	H mm	Finitura/Finishing
20F JIM1 C130Z	130	cromato/chromed

☞ 24

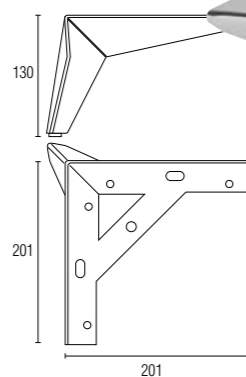

### maxi jim

● FE

Art	H mm	Finitura/Finishing
20F JIM2 C130Z	130	cromato/chromed

☞ 24

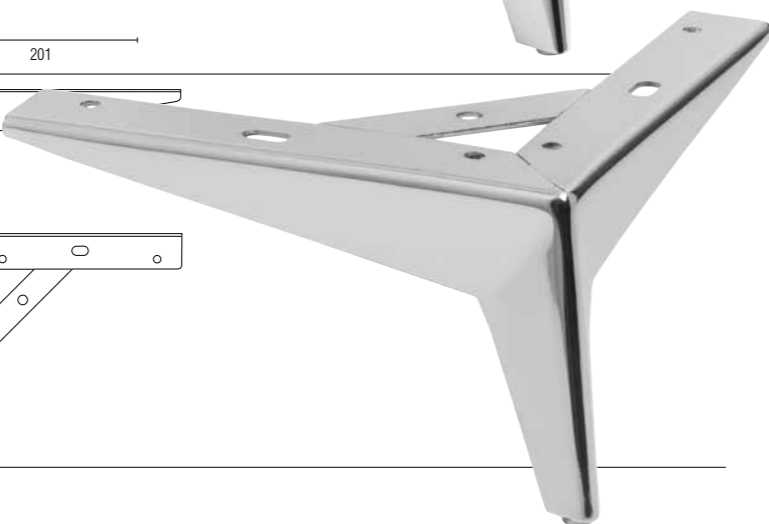
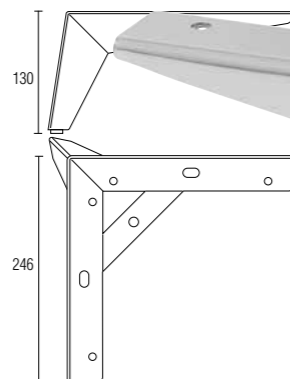

### molly 1

● FE

Art	H mm	Finitura/Finishing
20F MOL1 C150Z	150	cromato/chromed
20FMOL1GA150Z-NN	150	GA-NN nickel nero-black nickel

☞ 24

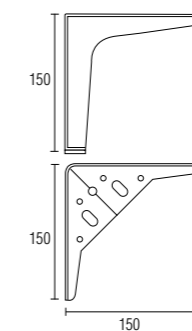

new entry

### shelly

● FE

Art	H mm	Finitura/Finishing
20F SHE C130Z	130	cromato/chromed
20F SHE O130Z	130	satinato/satin
30F SHE VP130Z/50L	130	VP-50L nero/black

☞ 48

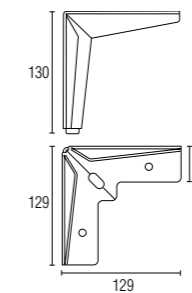

### palm 1

● FE

Art	H mm	Finitura/Finishing
20F PAL1 C100Z	100	cromato/chromed

☞ 48

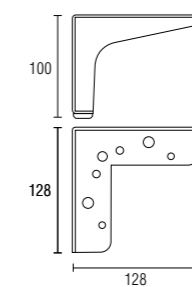

### adi

● FE

Art	H mm	Finitura/Finishing
20F ADI C120S	120	cromato/chromed

☞ 48

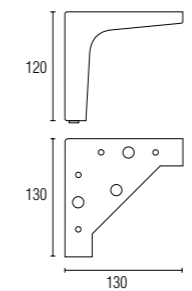

### meta

● FE

Art	H mm	Finitura/Finishing
20F MET C130Z	130	cromato/chromed
20F MET O130Z	130	satinato/satin
20F MET C150Z	150	cromato/chromed
20F MET O150Z	150	satinato/satin
20F MET C170Z	170	cromato/chromed
20F MET O170Z	170	satinato/satin

☞ 48

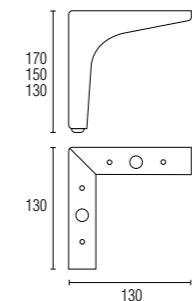

### malibù

● FE

Art	H mm	Finitura/Finishing
20F MAL C060S	50	cromato/chromed
20F MAL O060S	50	satinato/satin
20F MAL C080S	80	cromato/chromed
20F MAL O080S	80	satinato/satin

☞ 24



### genova

● FE

Art	H mm	Finitura/Finishing
20F GEN C195Z	60	cromato/chromed

☞ 24



### long island

● FE

Art	H mm	Finitura/Finishing
20F LON C200S	60	cromato/chromed

☞ 24



### master

● AL

Art	H mm	Finitura/Finishing
20A DOI L060S	60	lucido/polished
20A DOI O060S	60	opaco/mat

☞ 24



### maschera

● AL

Art	H mm	Finitura/Finishing
20A MAS L100S	100	lucido/polished
20A MAS S100S	100	opaco/mat

☞ 24



### noè

● FE

Art	H mm	Finitura/Finishing
20F NOE C105Z	105	cromato/chromed
20F NOE C135Z	135	cromato/chromed

☞ 24



### arca

● FE

Art	H mm	Finitura/Finishing
20F ARCA C100Z	100	cromato/chromed

☞ 24

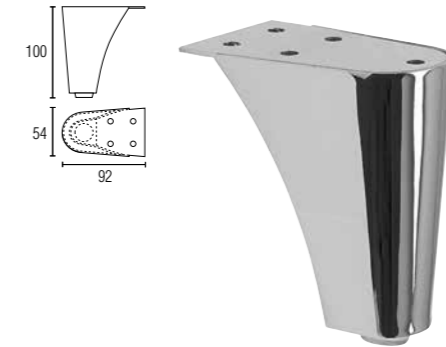

### fiona

● FE

Art	H mm	Finitura/Finishing
20F FIO C100Z	100	cromato/chromed

☞ 24



### gemma

● FE

Art	H mm	Finitura/Finishing
20F GEM C060Z	60	cromato/chromed
20F GEM C105Z	105	cromato/chromed

☞ 48

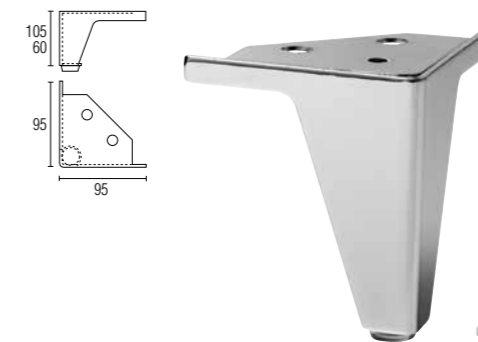

### neutrone

● FE

Art	H mm	Finitura/Finishing
20F NEUT C195Z	195	cromato/chromed
30F NEUT VP195Z/50L	195	VP-50L nero/black

☞ 48

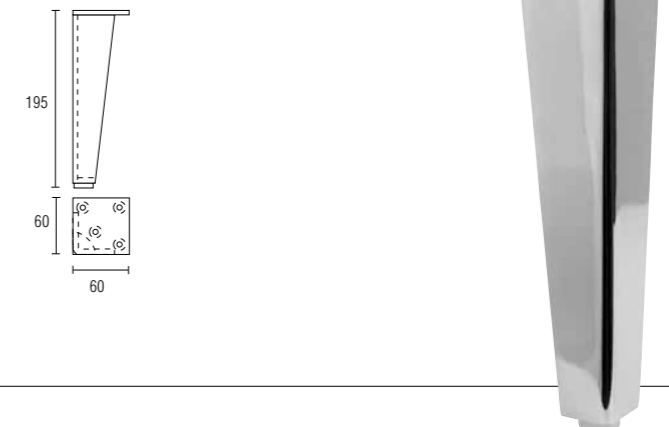

### paddock

● AL

Art	H mm	Finitura/Finishing
20A PAD L170S	170	lucido/polished
20A PAD O170S	170	opaco/mat

☞ 24

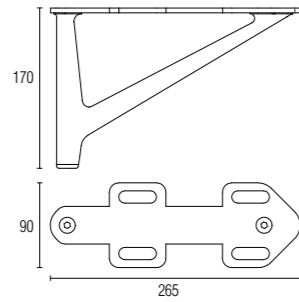

### fionda

● AL

Art	H mm	Finitura/Finishing
20A FION L130S	130	lucido/polished
20A FION O130S	130	opaco/mat
20A FION L149S	149	lucido/polished
20A FION O149S	149	opaco/mat
20A FION L169S	169	lucido/polished
20A FION O169S	169	opaco/mat

☞ 16

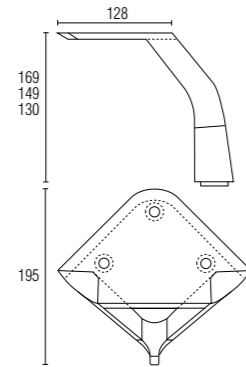

### tdf

● FE

Art	H mm	Finitura/Finishing
20F TDF C120Z	120	cromato/chromed
20F TDF C160Z	160	cromato/chromed

☞ 24

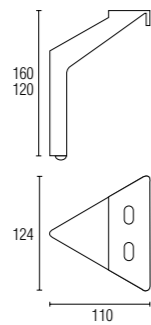

### spacer

● FE

Art	H mm	Finitura/Finishing
20F SPA C140Z	140	cromato/chromed

☞ 48

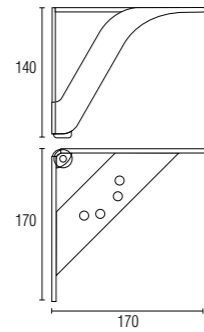

### empty

● FE

Art	H mm	Finitura/Finishing
20F EMP C120Z	120	cromato/chromed

☞ 24

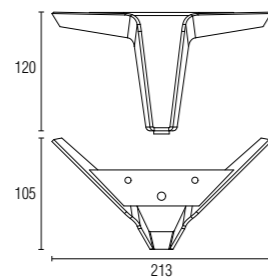

### tilt 1

● FE

Art	H mm	Finitura/Finishing
20F TIL1 C110Z	110	cromato/chromed
20F TIL1 C140Z	140	cromato/chromed
20PT TILT 85N	-	puntale/tip

☞ 48

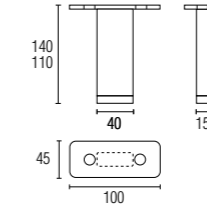

20PT TILT 85N

Puntale opzionale ø 85 mm  
Optional cap ø 85 mm  
Optionale Kappe ø 85 mm  
Tapon opcional ø 85 mm

### tilt 2

● FE

Art	H mm	Finitura/Finishing
20F TIL2 C110Z	110	cromato/chromed

☞ 48

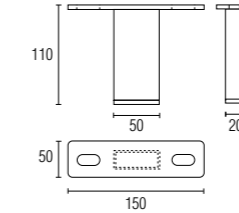

### tilt 3

● FE

Art	H mm	Finitura/Finishing
20F TIL3 C120Z	120	cromato/chromed

☞ 48

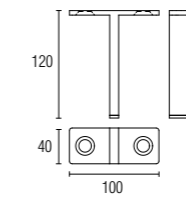

### tilt alluminio

● AL

Art	H mm	Finitura/Finishing
20A TIL L110	110	lucido/polished
20A TIL O110	110	opaco/mat
20A TIL L140	140	lucido/polished
20A TIL O140	140	opaco/mat

☞ 60

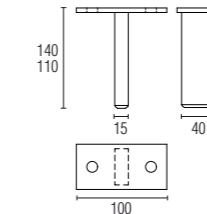

### adriatico

● FE

Art	H mm	Cromato Chromed	Opaco Mat	Destro Right	Sinistro Left
20F ADR C130DXS	130	•		•	
20F ADR C130SXS	130	•			•
20F ADR O130DXS	130		•	•	
20F ADR O130SXS	130		•		•

☞ 10

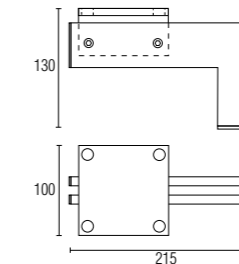

### 9010

AL

Art	H mm	Finitura/Finishing
20A 9010 L100S	100	lucido/polished
20A 9010 S100S	100	opaco/mat

24

Modello con spigolo vivo  
Model with sharp corner  
Modell mit gerader Ecke  
Modelo con esquina recta

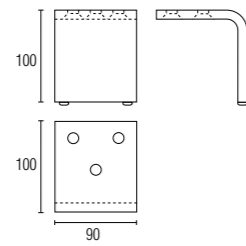

### 9011

AL

Art	H mm	Finitura/Finishing
20A 9011 L060S	60	lucido/polished
20A 9011 S060	60	opaco/mat
20A 9011 L100	100	lucido/polished
20A 9011 S100	100	opaco/mat
20A 9011 L130	130	lucido/polished
20A 9011 S130	130	opaco/mat
20A 9011 L170	170	lucido/polished
20A 9011 S170	170	opaco/mat

24

Modello con spigolo smussato  
Model with round corner  
Modell mit abgerundeter Ecke  
Modelo con esquina redondeada

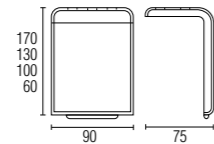

### 9011 ferro

FE

Art	H mm	Finitura/Finishing
20F 9011 C100Z	100	cromato/chromed
20F 9011 C120Z	120	cromato/chromed

24

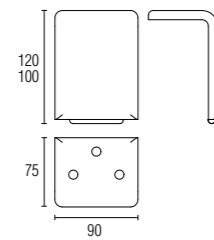

### 608

AL

Art	H mm	Finitura/Finishing
20A 608 L110	110	lucido/polished
20A 608 O110	110	opaco/mat

60

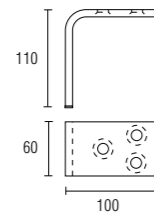

### cayman

FE

Art	H mm	Finitura/Finishing
20F CAY C120S	120	cromato/chromed

48

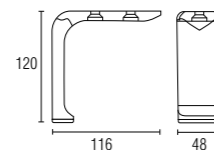

### roma

AL

Art	H mm	Finitura/Finishing
20A ROM L100	100	lucido/polished
20A ROM O100	100	opaco/mat

24

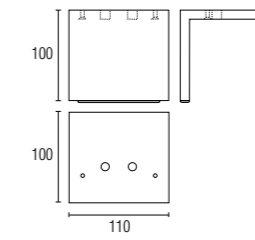

### roma ferro

FE

Art	H mm	Finitura/Finishing
20F ROM C120Z	120	cromato/chromed

24

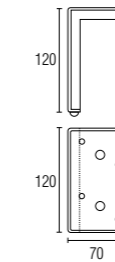

### stoccarda

AL

Art	H mm	Finitura/Finishing
20A STO LS080S	80	lucido-spazzolato/polished-brushed

24

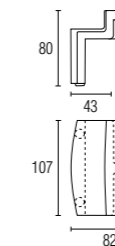

### milano

AL

Art	L mm	Finitura/Finishing
20A MIL L060140	140	lucido/polished
20A MIL O060140	140	opaco/mat
20A MIL L060180	180	lucido/polished
20A MIL O060180	180	opaco/mat
20A MIL L060220	220	lucido/polished
20A MIL O060220	220	opaco/mat

24

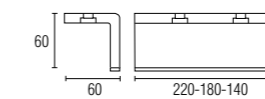

### corallo

FE

Art	L mm	Finitura/Finishing
20F COR C140Z	140	cromato/chromed
20F COR C180Z	180	cromato/chromed

24

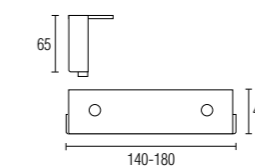



### trucco

Art	H mm	Finitura/Finishing
20F TRU C085T	85	cromato/chromed

● FE

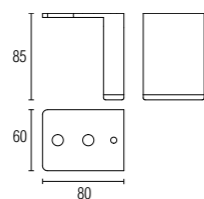

new entry

### graffiti 1

Art	L mm	Finitura/Finishing
20F GRA1 C100Z	100	cromato/chromed
20F GRA1 C200Z	200	cromato/chromed
20F GRA1 C240Z	240	cromato/chromed

● FE

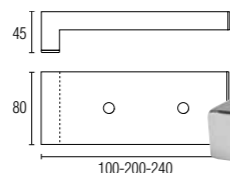

### teseo

Art	H mm	Finitura/Finishing
20F TES C050	50	cromato/chromed

● FE

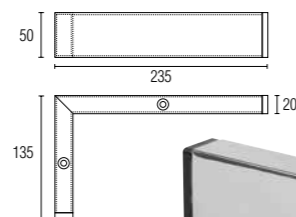

### hades

Art	L mm	Finitura/Finishing
20F HAD C150Z	150	cromato/chromed
20F HAD C220Z	220	cromato/chromed
20F HAD C250Z	250	cromato/chromed

● FE

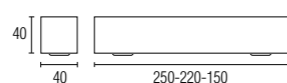

### hermes

Art	H mm	Finitura/Finishing
20A HER L045	45	lucido/polished
20A HER O045	45	opaco/mat

● AL

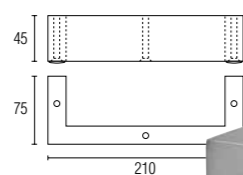

### full

Art	H mm	Destro Right	Sinistro Left	Finitura/Finishing
20F FUL C020DXZ	20	•		cromato/chromed
20F FUL C020SXZ	20		•	cromato/chromed

● FE

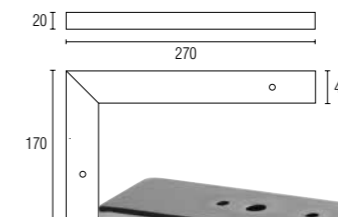

### paride

Art	H mm	Finitura/Finishing
20F PAR CS035S	35	cromo stainato/chrome satin

● FE

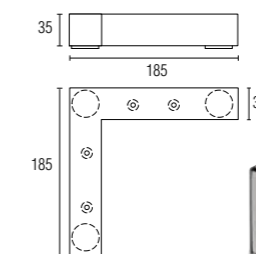

### funny

Art	H mm	Finitura/Finishing
20F FUN C035	35	cromato/chromed

● FE

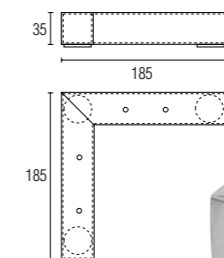

### talos

Art	H mm	Finitura/Finishing
20F TAL C035S	35	lucido/polished

● AL

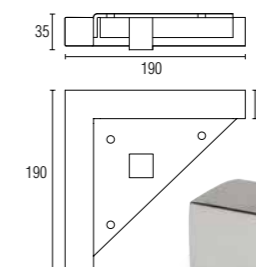

### messico

Art	L mm	Finitura/Finishing
20F MES C250Z	250	cromato/chromed
20F MES C320Z	320	cromato/chromed

● FE

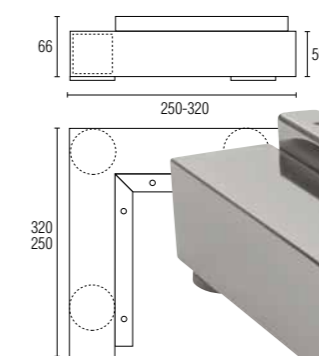

### athos

● Al

Art	H mm	Finitura/Finishing
20F RET C018S	22	lucido/polished
20F RET C023S	22	lucido/polished

☞ 24

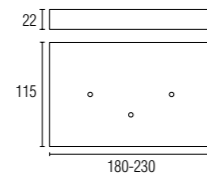

### aramis

● Al

Art	H mm	Finitura/Finishing
20F QUA C11X11S	22	lucido/polished

☞ 24

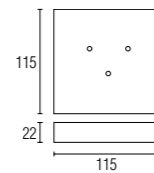

### porthos

● FE

Art	H mm	Finitura/Finishing
20F QUA C21X12S	45	cromato/chromed

☞ 24

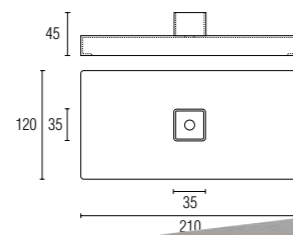

### melvin

● Al/LE

Art	H mm	Finitura/Finishing
20F MEL L025S	25	lucido/polished
20L MEL 215X115	25	noce/walnut

☞ 48

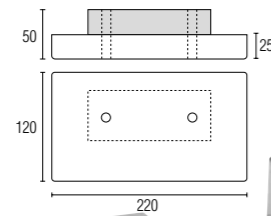

20L CAL 241X112



20F CAL L030S



### call

● Al/LE

Art	H mm	Finitura/Finishing
20F CAL L030S	30	lucido/polished
20L CAL 241X112	30	nero/blacks/

☞ 48

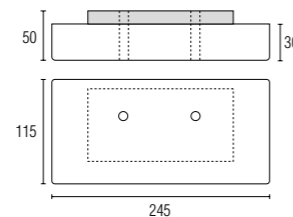

20L CAL 241X112



20F CAL L030S



### pm244

● Al/LE

Art	H mm	Finitura/Finishing
20F PM244 L070	70	lucido/polished

☞ 24

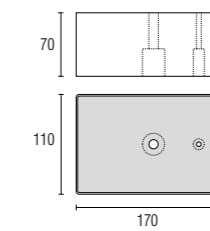

### pm233

● Al/LE

Art	H mm	Finitura/Finishing
20F PM233 L060	60	lucido/polished

☞ 24

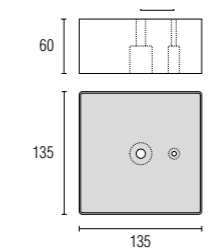

### pm530

● Al/LE

Art	H mm	Finitura/Finishing
20F PM530 L060	60	lucido/polished

☞ 48

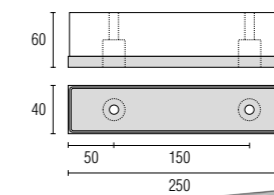

### nexus

● FE

Art	H mm	Finitura/Finishing
20F NEX C085T	85	cromato/chromed

☞ 24

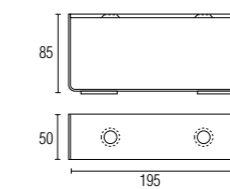

### pagoda

● FE

Art	H mm	Finitura/Finishing
20F PAG C145	145	cromato/chromed

☞ 12

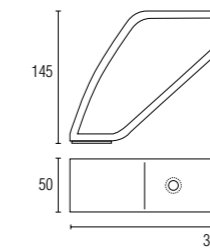

### zotta

● AL

Art	H mm	Finitura/Finishing
20A ZOT L080	80	lucido/polished
20A ZOT O080	80	opaco/mat
20A ZOT L115	115	lucido/polished
20A ZOT O115	115	opaco/mat
20A ZOT L135	135	lucido/polished
20A ZOT O135	135	opaco/mat

☞ 12

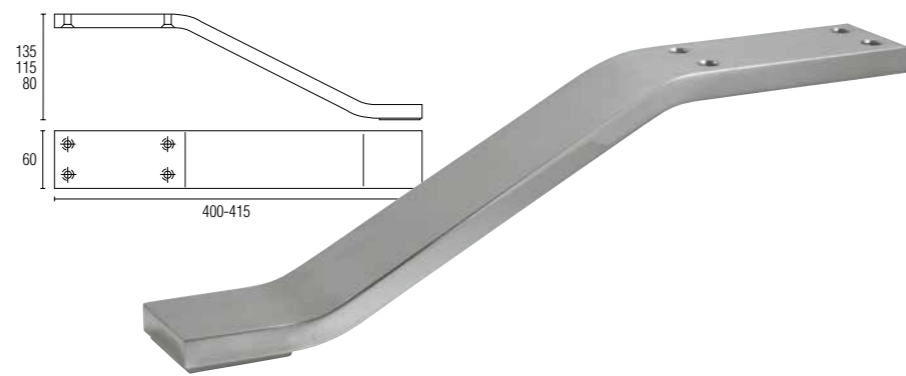

### zoe

● AL

Art	H mm	Finitura/Finishing
20A ZOE L115	115	lucido/polished
20A ZOE O115	115	opaco/mat

☞ 12

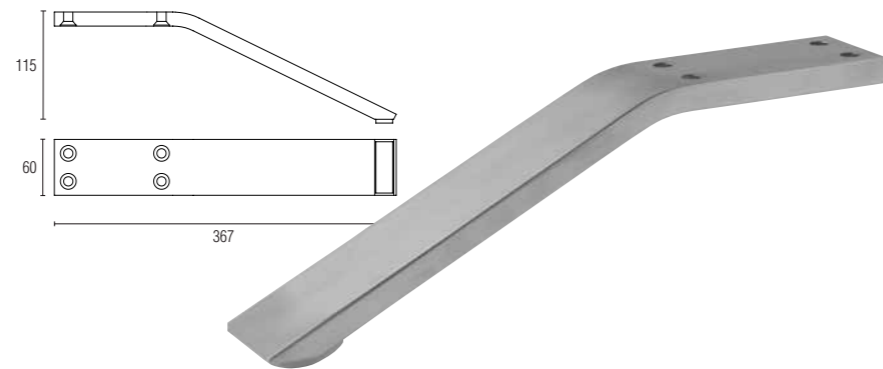

### tivoli

● FE

Art	H mm	Finitura/Finishing
20F TIV C130T	130	cromato/chromed

☞ 8



### arco

● AL

Art	H mm	Finitura/Finishing
20A 474 L145NAT	145	lucido/polished
20A 474 O145NAT	145	opaco/mat

☞ 24

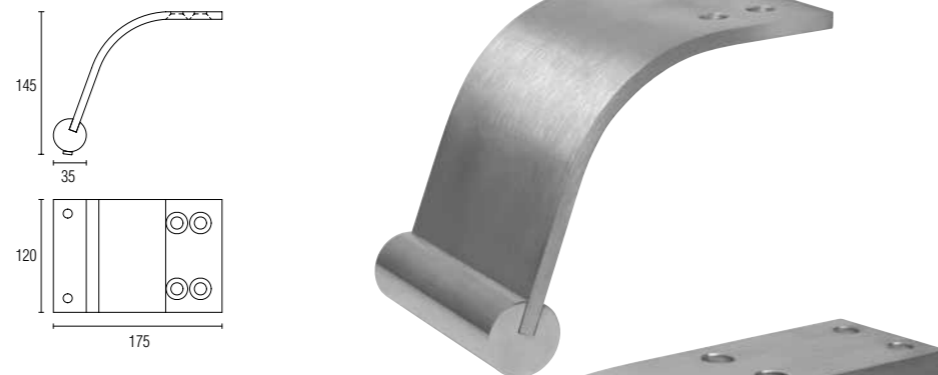

### cuero

● AL

Art	H mm	Finitura/Finishing
20A CUR L175	175	lucido/polished
20A CUR O175	175	opaco/mat

☞ 24

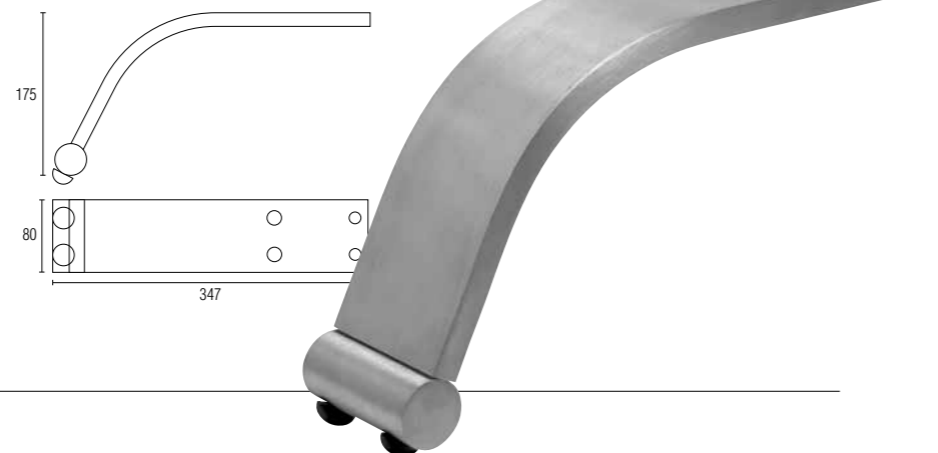

### venecia

● FE

Art	H mm	Finitura/Finishing
20F VEN C120Z	120	cromato/chromed

☞ 24

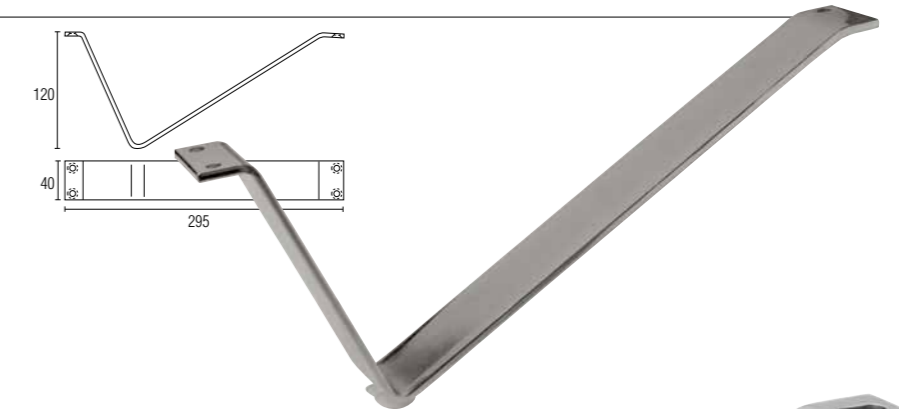

### albatros

● FE

Art	H mm	Finitura/Finishing
20F ALB C124Z	124	cromato/chromed

☞ 24

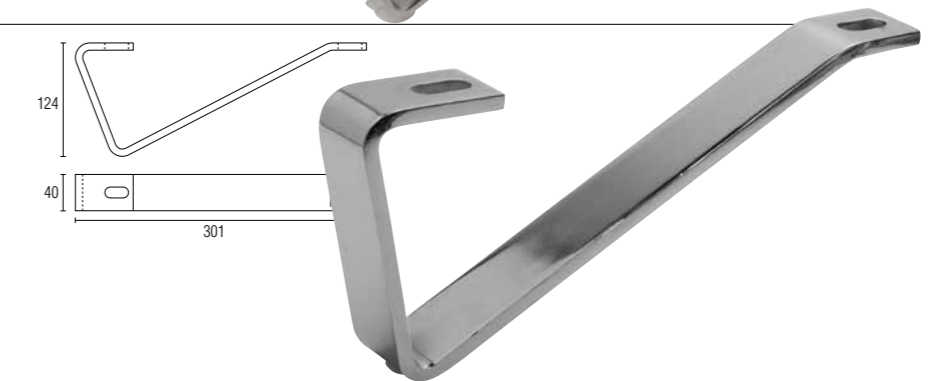

### swan

● FE

Art	H mm	Finitura/Finishing
20F SWA C150Z	150	cromato/chromed

☞ 48

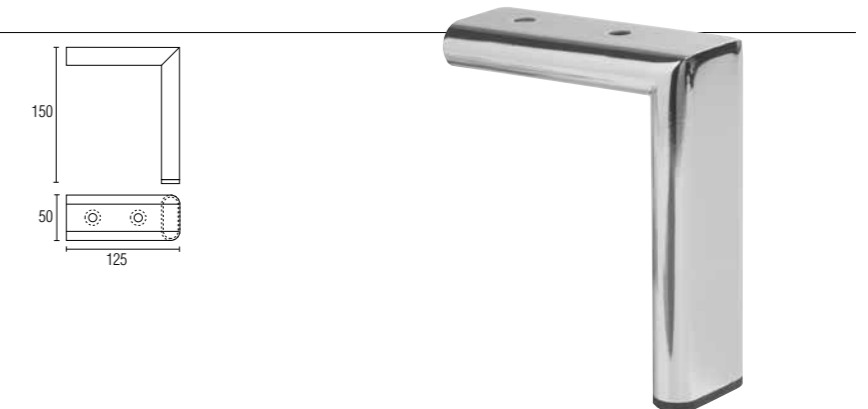

### ocean

● FE

Art	H mm	Finitura/Finishing
20F OCE C110S	110	cromato/chromed
30F OCE VP110S/50	110	VP-50 nero/black
20F OCE C130S	130	cromato/chromed
30F OCE VP130S/50	130	VP-50 nero/black
20F OCE C140S	140	cromato/chromed
30F OCE VP140S/50	140	VP-50 nero/black
20F OCE C160S	160	cromato/chromed
30F OCE VP160S /50	160	VP-50 nero/black

☞ 48

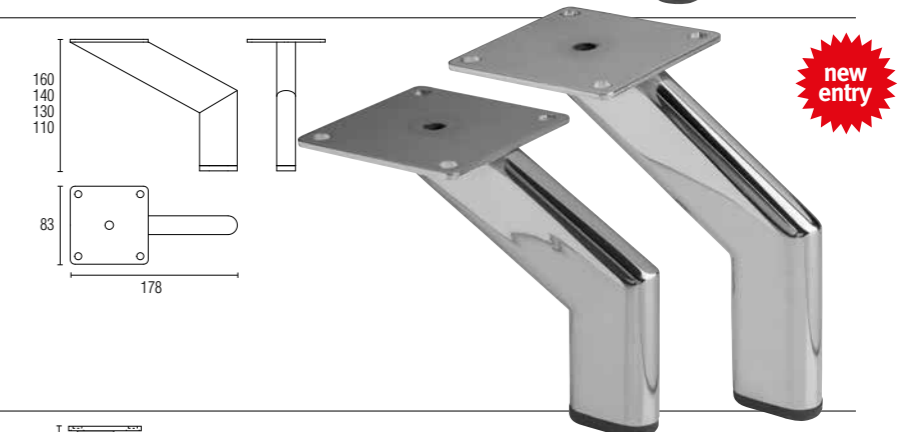

### mediterraneo

● FE

Art	H mm	Finitura/Finishing
20F MED C120Z	120	cromato/chromed

☞ 48



### tabù

● AL

Art	H mm	Finitura/Finishing
20A TAB L120	120	lucido/polished
20A TAB O120	120	opaco/mat
20A TAB L140	140	lucido/polished
20A TAB O140	140	opaco/mat
20A TAB L180	180	lucido/polished
20A TAB O180	180	opaco/mat

☞ 48

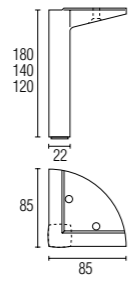

### italo

● FE

Art	H mm	Finitura/Finishing
20F ITA C150Z	150	cromato/chromed

☞ 48

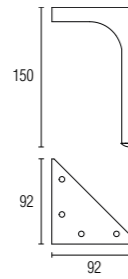

### sesto

● FE

Art	H mm	Finitura/Finishing
20F SES C130S	130	cromato/chromed
20F SES O130S	130	opaco/mat
20F SES C150S	150	cromato/chromed
20F SES O150S	150	opaco/mat

☞ 48

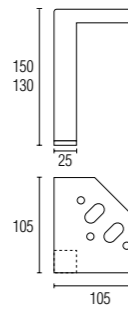

### fogo

● FE

Art	H mm	Finitura/Finishing
20F FOG C170S	170	cromato/chromed
20F FOG O170S	170	opaco/mat

☞ 24

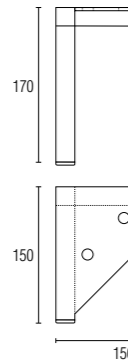

### pps

● FE

Art	H mm	Cromato Chromed	Destro Right	Sinistro Left
20F PPS C100DS	100	●	●	
20F PPS C100SS	100	●		●

☞ 48

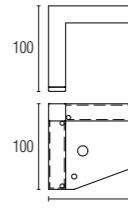

### park

● FE

Art	H mm	Finitura/Finishing
20F PARK C080S	80	cromato/chromed
20F PARK C100S	100	cromato/chromed

☞ 24

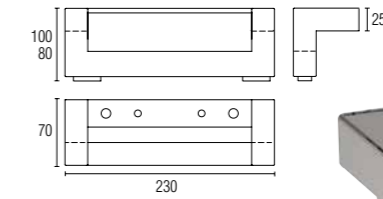

### venus

● FE

Art	H mm	Finitura/Finishing
20F VENU C075S	75	cromato/chromed

☞ 24

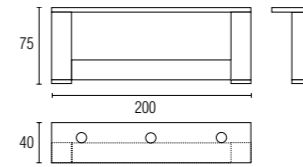

### garden

● FE

Art	L mm	Finitura/Finishing
20F GAR C210S	210	cromato/chromed
20F GAR C160S	160	cromato/chromed

☞ 48

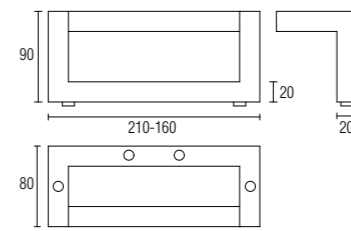

### jardin

● FE

Art	H mm	Cromato Chromed	Destro Right	Sinistro Left
20F JAR C220DXS	90	●	●	
20F JAR C220SXS	90	●		●

☞ 48

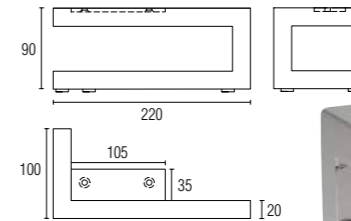

### madison

● FE

Art	H mm	Finitura/Finishing
20F MAD C250S	85	cromato/chromed

☞ 24

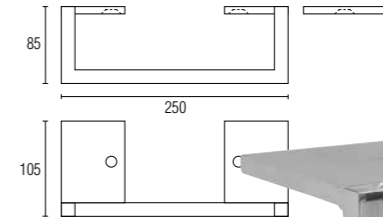

### valle

● FE

Art	L mm	Finitura/Finishing
20F VAL C150Z	150	cromato/chromed
20F VAL C180Z	180	cromato/chromed
20F VAL C220Z	220	cromato/chromed
20F VAL C285Z	285	cromato/chromed

☞ 24

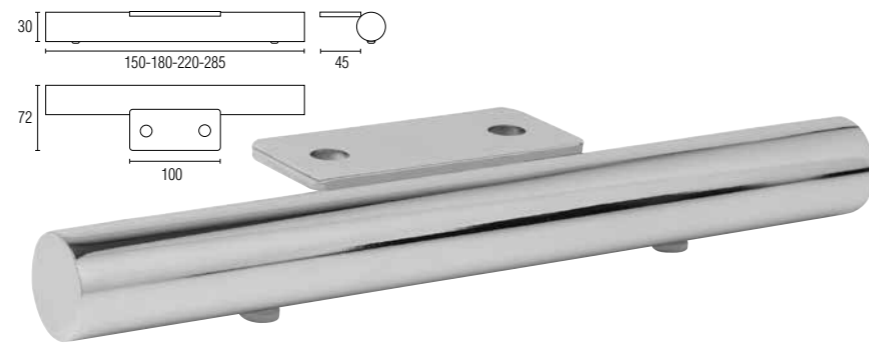

### marte

● FE

Art	L mm	Finitura/Finishing
20F MART C120Z	120	cromato/chromed
20F MART C170Z	170	cromato/chromed
20F MART C205Z	205	cromato/chromed
20F MART C250Z	250	cromato/chromed

☞ 48

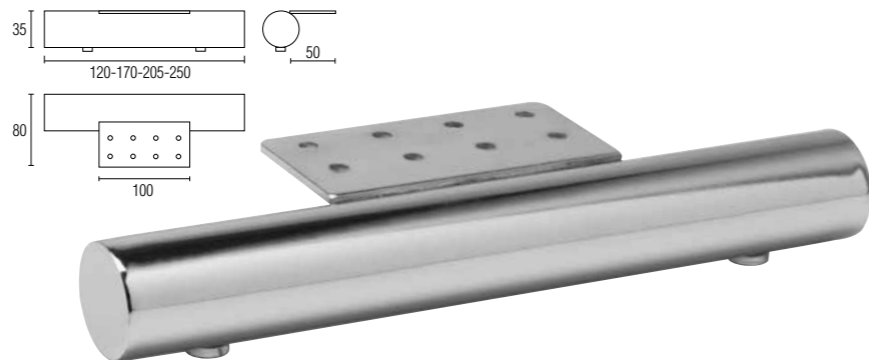

### zeus

● FE

Art	L mm	Finitura/Finishing
20F ZEU C110Z	110	cromato/chromed
20F ZEU C150Z	150	cromato/chromed
20F ZEU C200Z	200	cromato/chromed
20F ZEU C220Z	220	cromato/chromed
20F ZEU C300Z	300	cromato/chromed

☞ 24

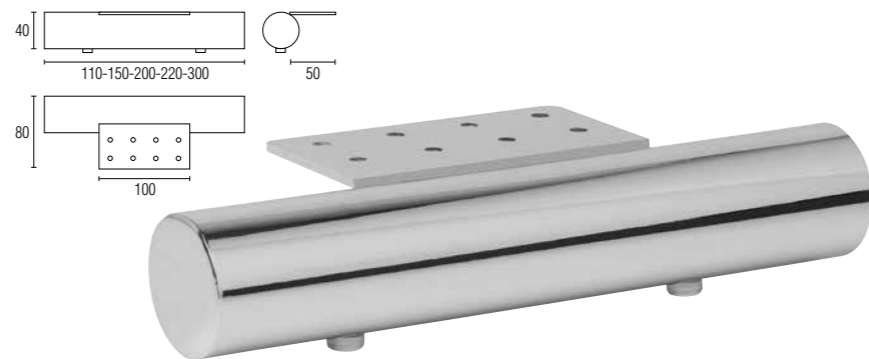

### odin

● FE

Art	L mm	Finitura/Finishing
20F ODI C220Z	220	cromato/chromed

☞ 48

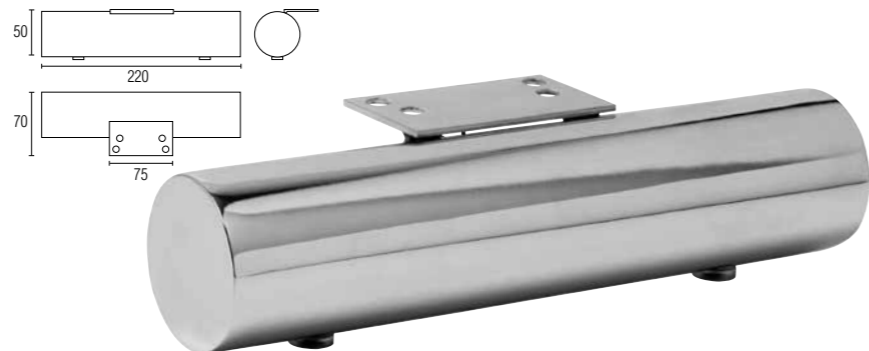

### vuzero

● AL

Art	L mm	Finitura/Finishing
20A VUZ L225S	225	lucido/polished

☞ 24

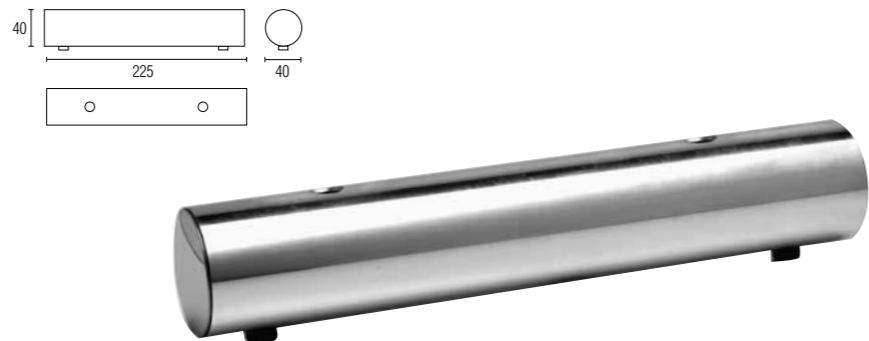

### rikota

● FE

Art	L mm	Finitura/Finishing
20F RIK C220Z	220	cromato/chromed

☞ 48

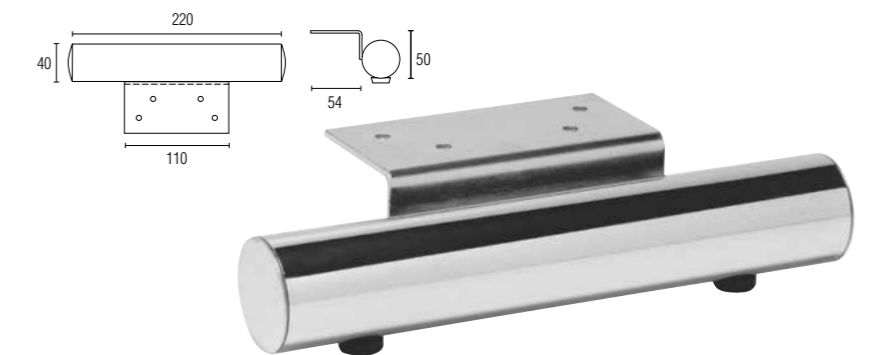

### agata

● FE

Art	L mm	Finitura/Finishing
20F AGA C190Z	190	cromato/chromed
20F AGA C250Z	250	cromato/chromed

☞ 48

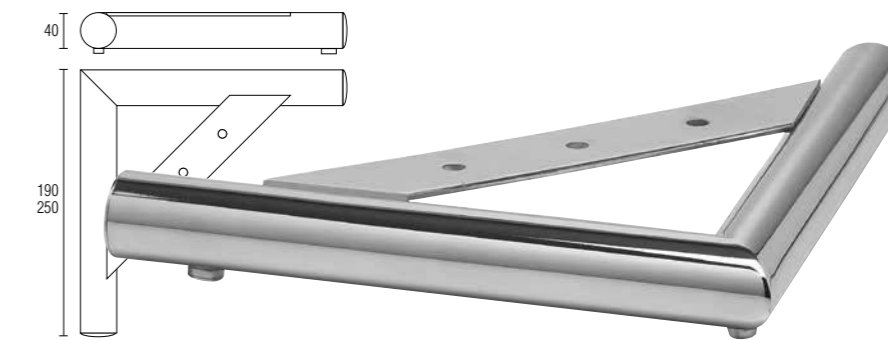

### degas

● AL

Art	H mm	Finitura/Finishing
20A DEG L200S	35	lucido/polished
20A DEG O200S	35	opaco/mat

☞ 24

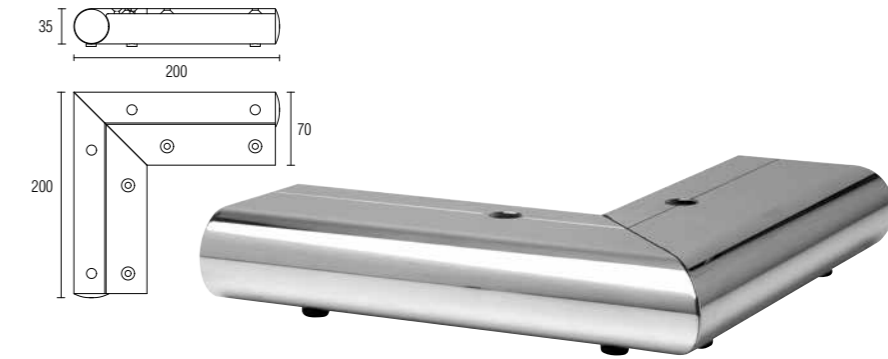

### samba

● FE

Art	L mm	Finitura/Finishing
20F SAM C120Z	120	cromato/chromed
20F SAM C220Z	220	cromato/chromed
20F SAM C320Z	320	cromato/chromed

☞ 48



### rodin

● AL

Art	L mm	Finitura/Finishing
20A ROD L200	200	lucido/polished
20A ROD O200	200	opaco/mat

☞ 24

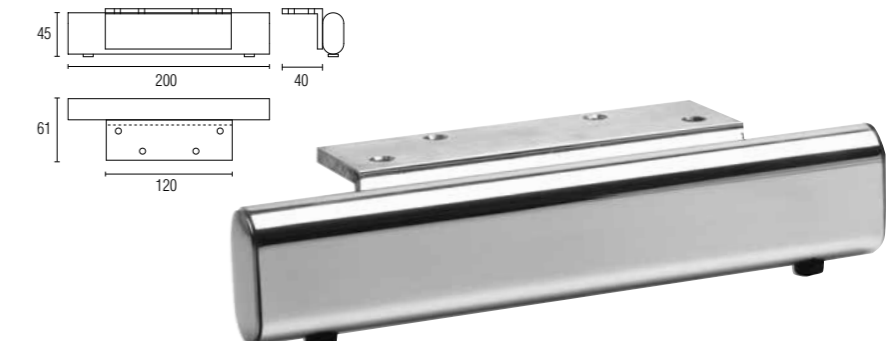

### conico

Art	H mm	Finitura/Finishing
20L L6/MIE	60	miele/light brown
20L L6/CIL	60	ciliegio/cherry wood
20L L6/NOC	60	noce/nutbrown
20L L6/WEN	60	wenghe
20L L8/MIE	80	miele/light brown
20L L8/CIL	80	ciliegio/cherry wood
20L L8/NOC	80	noce/nutbrown
20L L8/WEN	80	wenghe
20L L10/MIE	100	miele/light brown
20L L10/CIL	100	ciliegio/cherry wood

Art	H mm	Finitura/Finishing
20L L10/NOC	100	noce/nutbrown
20L L10/WEN	100	wenghe
20L L12/MIE	120	miele/light brown
20L L12/CIL	120	ciliegio/cherry wood
20L L12/NOC	120	noce/nutbrown
20L L12/WEN	120	wenghe
20L L14/MIE	140	miele/light brown
20L L14/CIL	140	ciliegio/cherry wood
20L L14/NOC	140	noce/nutbrown
20L L14/WEN	140	wenghe

72

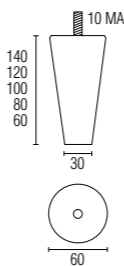

### conico con ruota

Art	H mm	Finitura/Finishing
20L L6/MIE+20RROM	105	miele/light brown
20L L6/CIL+20RROM	105	ciliegio/cherry wood
20L L6/NOC+20RROM	105	noce/nutbrown
20L L6/WEN+20RROM	105	wenghe
20L L8/MIE+20RROM	125	miele/light brown
20L L8/CIL+20RROM	125	ciliegio/cherry wood
20L L8/NOC+20RROM	125	noce/nutbrown
20L L8/WEN+20RROM	125	wenghe

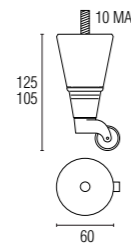

### conico con incavo

Art	H mm	Finitura/Finishing
20L L6/MIE	60	miele/light brown
20L L6/CIL	60	ciliegio/cherry wood
20L L6/NOC	60	noce/nutbrown
20L L6/WEN	60	wenghe
20L L8/MIE	80	miele/light brown
20L L8/CIL	80	ciliegio/cherry wood
20L L8/NOC	80	noce/nutbrown
20L L8/WEN	80	wenghe

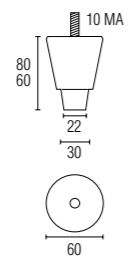

### flauto

Art	H mm	Finitura/Finishing
20L FLAU 100S/20	100	nero/black
20L FLAU 130S/20	130	nero/black

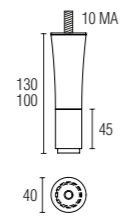

### cilindrico

Art	H mm	Finitura/Finishing
20L L4C/MIE	40	miele/light brown
20L L4C/CIL	40	ciliegio/cherry wood
20L L4C/NOC	40	noce/nutbrown
20L L4C/WEN	40	wenghe
20L L6C/MIE	60	miele/light brown
20L L6C/CIL	60	ciliegio/cherry wood
20L L6C/NOC	60	noce/nutbrown
20L L6C/WEN	60	wenghe

Art	H mm	Finitura/Finishing
20L L8C/MIE	80	miele/light brown
20L L8C/CIL	80	ciliegio/cherry wood
20L L8C/NOC	80	noce/nutbrown
20L L8C/WEN	80	wenghe
20L L10C/MIE	100	miele/light brown
20L L10C/CIL	100	ciliegio/cherry wood
20L L10C/NOC	100	noce/nutbrown
20L L10C/WEN	100	wenghe

72

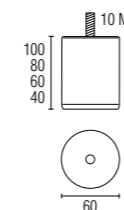

### cipolla

Art	ø mm	H mm	Finitura/Finishing
20L M135 P/MIE	35	70	miele/light brown
20L M135 P/CIL	35	70	ciliegio/cherry wood
20L M135 P/NOC	35	70	noce/nutbrown
20L M135 P/WEN	35	70	wenghe
20L M135 M/MIE	45	90	miele/light brown
20L M135 M/CIL	45	90	ciliegio/cherry wood
20L M135 M/NOC	45	90	noce/nutbrown
20L M135 M/WEN	45	90	wenghe
20L M135 G/MIE	45	120	miele/light brown
20L M135 G/CIL	45	120	ciliegio/cherry wood
20L M135 G/NOC	45	120	noce/nutbrown
20L M135 G/WEN	45	120	wenghe

72

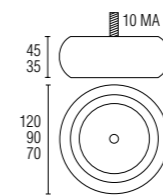

### cester

Art	H mm	Finitura/Finishing
20L CEST 080/CIL	80	ciliegio/cherry wood
20L CEST 080/MIE	80	miele/light brown
20L CEST 080/NOC	80	noce/nutbrown
20L CEST 080/WEN	80	wenghe

72

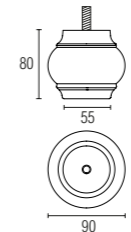

### cippendale

Art	H mm	Finitura/Finishing
20L CIP 130/CIL	130	ciliegio/cherry wood
20L CIP 130/MIE	130	miele/light brown
20L CIP 130/NOC	130	noce/nutbrown
20L CIP 130/WEN	130	wenghe

72

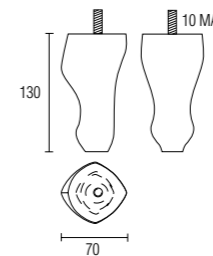

### stendhal

Art	H mm	Finitura/Finishing
20L STE1 150/CIL	150	ciliegio/cherry wood
20L STE1 150/MIE	150	miele/light brown
20L STE1 150/NOC	150	noce/nutbrown
20L STE1 150/WEN	150	wenghe

72

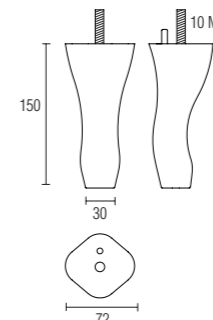

### barocco

Art	H mm	Finitura/Finishing
20L M160/MIE	160	miele/light brown
20L M160/CIL	160	ciliegio/cherry wood
20L M160/NOC	160	noce/nutbrown
20L M160/WEN	160	wenghe

72

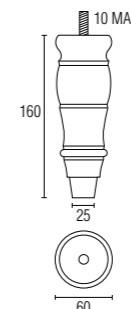

### lq

Art	H mm	Finitura/Finishing
20L LQ 7/MIE	70	miele/light brown
20L LQ 7/CIL	70	ciliegio/cherry wood
20L LQ 7/NOC	70	noce/nutbrown
20L LQ 7/WEN	70	wenghe
20L LQ 8/MIE	80	miele/light brown
20L LQ 8/CIL	80	ciliegio/cherry wood
20L LQ 8/NOC	80	noce/nutbrown
20L LQ 8/WEN	80	wenghe

LE

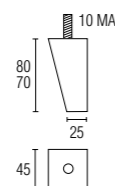

### lqg 10

Art	H mm	Finitura/Finishing
20L LQG 10/MIE	100	miele/light brown
20L LQG 10/CIL	100	ciliegio/cherry wood
20L LQG 10/NOC	100	noce/nutbrown
20L LQG 10/WEN	100	wenghe

LE

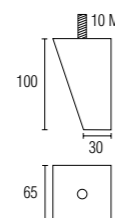

### lq 105

Art	H mm	Finitura/Finishing
20L LQ 105/MIE	100	miele/light brown
20L LQ 105/CIL	100	ciliegio/cherry wood
20L LQ 105/NOC	100	noce/nutbrown
20L LQ 105/WEN	100	wenghe

LE

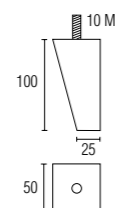

### giulio dritto

Art	H mm	Finitura/Finishing
20L GIU 205/MIE	200	miele/light brown
20L GIU 205/CIL	200	ciliegio/cherry wood
20L GIU 205/NOC	200	noce/nutbrown
20L GIU 205/WEN	200	wenghe

LE

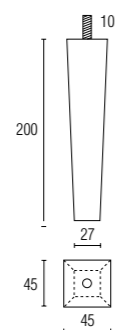

### giulio inclinato

Art	H mm	Finitura/Finishing
20L GIUI 205/MIE	205	miele/light brown
20L GIUI 205/CIL	205	ciliegio/cherry wood
20L GIUI 205/NOC	205	noce/nutbrown
20L GIUI 205/WEN	205	wenghe

LE

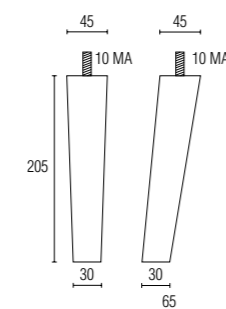

### enea

Art	H mm	Finitura/Finishing
20L ENE 090/CIL	90	ciliegio/cherry wood
20L ENE 090/MIE	90	miele/light brown
20L ENE 090/NOC	90	noce/nutbrown
20L ENE 090/WEN	90	wenghe

LE

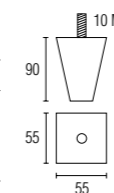

### orlando

Art	H mm	Finitura/Finishing
20L ORL 070/CIL	70	ciliegio/cherry wood
20L ORL 070/MIE	70	miele/light brown
20L ORL 070/NOC	70	noce/nutbrown
20L ORL 070/WEN	70	wenghe

LE

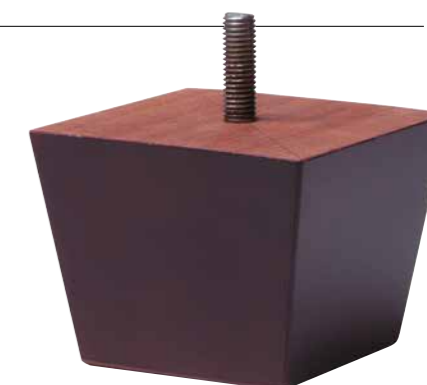
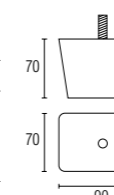

### 11

Art	H mm	Finitura/Finishing
20L 11 100/CIL	100	ciliegio/cherry wood
20L 11 100/MIE	100	miele/light brown
20L 11 100/NOC	100	noce/nutbrown
20L 11 100/WEN	100	wenghe

LE

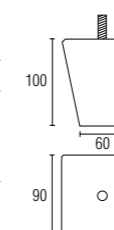

### 12

Art	H mm	Finitura/Finishing
20L 12 100/CIL	100	ciliegio/cherry wood
20L 12 100/MIE	100	miele/light brown
20L 12 100/NOC	100	noce/nutbrown
20L 12 100/WEN	100	wenghe

LE

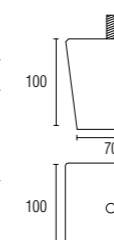

### obliquo

Art	H mm	Finitura/Finishing
20L M161/MIE	100	miele/light brown
20L M161/CIL	100	ciliegio/cherry wood
20L M161/NOC	100	noce/nutbrown
20L M161/WEN	100	wenghe

LE

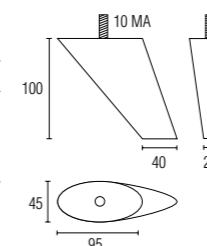

### dallas

Art	H mm	Finitura/Finishing
20L DAL 060/CIL	60	ciliegio/cherry wood
20L DAL 060/MIE	60	miele/light brown
20L DAL 060/NOC	60	noce/nutbrown
20L DAL 060/WEN	60	wenghe

☐ 24

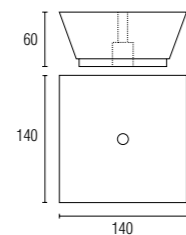

### bamboo

Art	H mm	Finitura/Finishing
20L BAM 085/CIL	85	ciliegio/cherry wood
20L BAM 085/MIE	85	miele/light brown
20L BAM 085/NOC	85	noce/nutbrown
20L BAM 085/WEN	85	wenghe

☐ 48

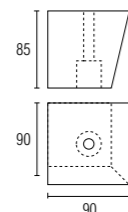

### garria

Art	H mm	Finitura/Finishing
20L GAR 060/CIL	60	ciliegio/cherry wood
20L GAR 060/MIE	60	miele/light brown
20L GAR 060/NOC	60	noce/nutbrown
20L GAR 060/WEN	60	wenghe

☐ 48

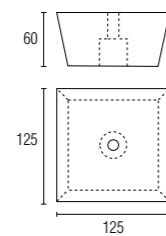

### titano

Art	H mm	Finitura/Finishing
20L TIT 060/CIL	60	ciliegio/cherry wood
20L TIT 060/MIE	60	miele/light brown
20L TIT 060/NOC	60	noce/nutbrown
20L TIT 060/WEN	60	wenghe

☐ 48

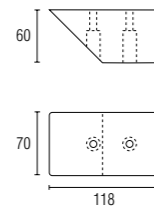

### luna

Art	H mm	Finitura/Finishing
20L LUN 050/CIL	50	ciliegio/cherry wood
20L LUN 050/MIE	50	miele/light brown
20L LUN 050/NOC	50	noce/nutbrown
20L LUN 050/WEN	50	wenghe

☐ 24

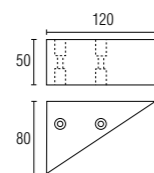

### santana

Art	H mm	Finitura/Finishing
20L SNT 050/CIL	50	ciliegio/cherry wood
20L SNT 050/MIE	50	miele/light brown
20L SNT 050/NOC	50	noce/nutbrown
20L SNT 050/WEN	50	wenghe

☐ 24

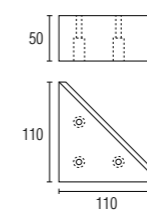

### nevada

Art	H mm	Finitura/Finishing
20L NEV 068/CIL	68	ciliegio/cherry wood
20L NEV 068/MIE	68	miele/light brown
20L NEV 068/NOC	68	noce/nutbrown
20L NEV 068/WEN	68	wenghe

☐ 24

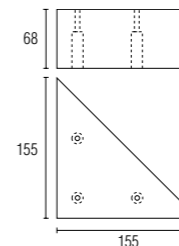

### miami

Art	H mm	Finitura/Finishing
20L MIA 075/CIL	75	ciliegio/cherry wood
20L MIA 075/MIE	75	miele/light brown
20L MIA 075/NOC	75	noce/nutbrown
20L MIA 075/WEN	75	wenghe

☐ 24

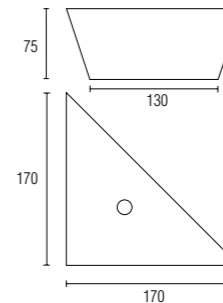

### salento

Art	H mm	Finitura/Finishing
20L SAL2 070/MIE	70	miele/light brown
20L SAL2 070/CIL	70	ciliegio/cherry wood
20L SAL2 070/NOC	70	noce/nutbrown
20L SAL2 070/WEN	70	wenghe

☐ 24

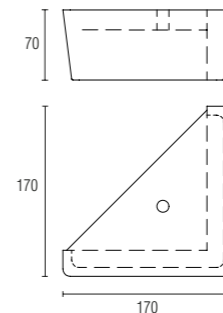

### cambridge

Art	H mm	Finitura/Finishing
20L CAM/MIE	120	miele/light brown
20L CAM/CIL	120	ciliegio/cherry wood
20L CAM/NOC	120	noce/nutbrown
20L CAM/WEN	120	wenghe

☐ 24

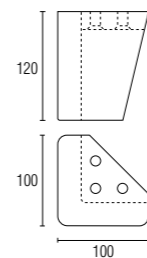



### leuca

LE

Art	H mm	Finitura/Finishing
20L LEU 045/MIE	45	miele/light brown
20L LEU 045/CIL	45	ciliegio/cherry wood
20L LEU 045/NOC	45	noce/nutbrown
20L LEU 045/WEN	45	wenghe

24

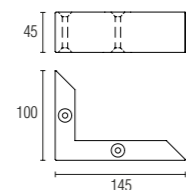

### lecce

LE

Art	H mm	Finitura/Finishing
20L LEC 040/MIE	40	miele/light brown
20L LEC 040/CIL	40	ciliegio/cherry wood
20L LEC 040/NOC	40	noce/nutbrown
20L LEC 040/WEN	40	wenghe

24

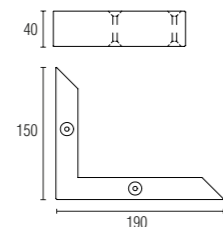

### margot

LE

Art	H mm	Finitura/Finishing
20L MAR 035/CIL	35	ciliegio/cherry wood
20L MAR 035/MIE	35	miele/light brown
20L MAR 035/NOC	35	noce/nutbrown
20L MAR 035/WEN	35	wenghe

24

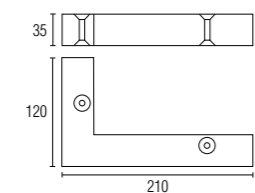

### honolulu

LE

Art	H mm	Destro Right	Sinistro Left	Finitura/Finishing
20L HON D050/CIL	50	•		ciliegio/cherry wood
20L HON S050/CIL	50		•	ciliegio/cherry wood
20L HON D050/MIE	50	•		miele/light brown
20L HON S050/MIE	50		•	miele/light brown
20L HON D050/NOC	50	•		noce/nutbrown
20L HON S050/NOC	50		•	noce/nutbrown
20L HON D050/WEN	50	•		wenghe
20L HON S050/WEN	50		•	wenghe

24

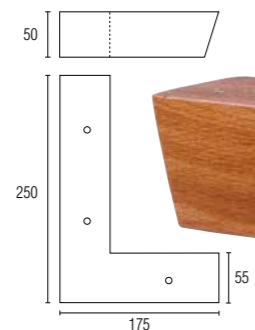

### ontario

LE

Art	H mm	Finitura/Finishing
20L ONT 030/CIL	35	ciliegio/cherry wood
20L ONT 030/MIE	35	miele/light brown
20L ONT 030/NOC	35	noce/nutbrown
20L ONT 030/WEN	35	wenghe

48

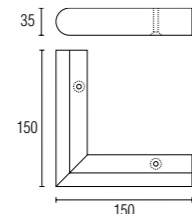

### los angeles

LE

Art	H mm	Finitura/Finishing
20L LOS 050/CIL	50	ciliegio/cherry wood
20L LOS 050/MIE	50	miele/light brown
20L LOS 050/NOC	50	noce/nutbrown
20L LOS 050/WEN	50	wenghe

24

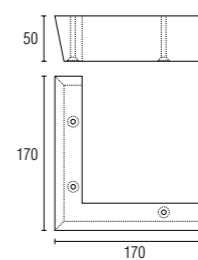

### oakland

LE

Art	H mm	Finitura/Finishing
20L OAK 055/CIL	55	ciliegio/cherry wood
20L OAK 055/MIE	55	miele/light brown
20L OAK 055/NOC	55	noce/nutbrown
20L OAK 055/WEN	55	wenghe

24

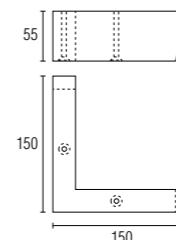

### las vegas

LE

Art	H mm	Finitura/Finishing
20L LAS/MIE	80	miele/light brown
20L LAS/CIL	80	ciliegio/cherry wood
20L LAS/NOC	80	noce/nutbrown
20L LAS/WEN	80	wenghe

24

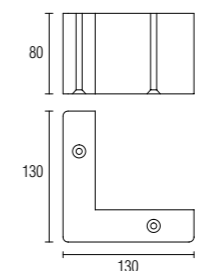

### cuba

LE

Art	H mm	Finitura/Finishing
20L CUB 050/CIL	50	ciliegio/cherry wood
20L CUB 050/MIE	50	miele/light brown
20L CUB 050/NOC	50	noce/nutbrown
20L CUB 050/WEN	50	wenghe

24

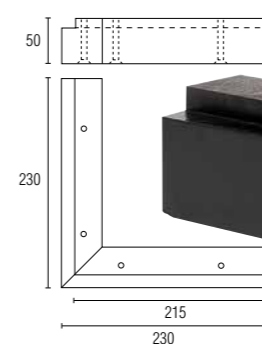

### buffalo

LE

Art	H mm	Destro Right	Sinistro Left	Finitura/Finishing
20L BUF D070/CIL	70	•		ciliegio/cherry wood
20L BUF S070/CIL	70		•	ciliegio/cherry wood
20L BUF D070/MIE	70	•		miele/light brown
20L BUF S070/MIE	70		•	miele/light brown
20L BUF D070/NOC	70	•		noce/nutbrown
20L BUF S070/NOC	70		•	noce/nutbrown
20L BUF D070/WEN	70	•		wenghe
20L BUF S070/WEN	70		•	wenghe

24

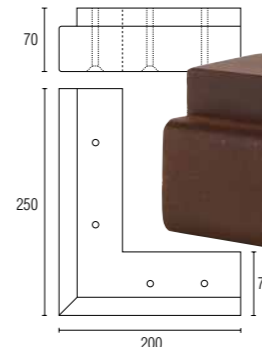

### rondine

LE

Art	H mm	Finitura/Finishing
20L RON 035/CIL	35	ciliegio/cherry wood
20L RON 035/MIE	35	miele/light brown
20L RON 035/NOC	35	noce/nutbrown
20L RON 035/WEN	35	wenghe

48

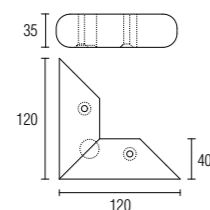

### monterey

LE

Art	H mm	Finitura/Finishing
20L MON 040/CIL	40	ciliegio/cherry wood
20L MON 040/MIE	40	miele/light brown
20L MON 040/NOC	40	noce/nutbrown
20L MON 040/WEN	40	wenghe

48

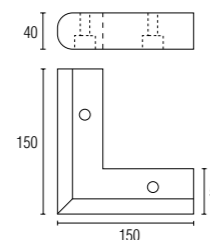

### mini

LE

Art	L mm	Finitura/Finishing
20L MIN 125/CIL	125	ciliegio/cherry wood
20L MIN 125/MIE	125	miele/light brown
20L MIN 125/NOC	125	noce/nutbrown
20L MIN 125/WEN	125	wenghe

48

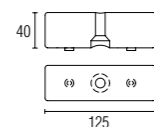

### tato

LE

Art	L mm	Finitura/Finishing
20L TAT 200/CIL	200	ciliegio/cherry wood
20L TAT 200/MIE	200	miele/light brown
20L TAT 200/NOC	200	noce/nutbrown
20L TAT 200/WEN	200	wenghe

48

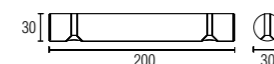

### togo

LE

Art	H mm	Finitura/Finishing
20L TOG 030/CIL	30	ciliegio/cherry wood
20L TOG 030/MIE	30	miele/light brown
20L TOG 030/NOC	30	noce/nutbrown
20L TOG 030/WEN	30	wenghe

48

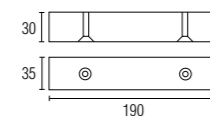

### tucson

LE

Art	H mm	Finitura/Finishing
20L TUC 050/CIL	50	ciliegio/cherry wood
20L TUC 050/MIE	50	miele/light brown
20L TUC 050/NOC	50	noce/nutbrown
20L TUC 050/WEN	50	wenghe

48

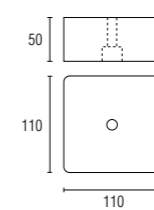

### alcea

LE

Art	H mm	Finitura/Finishing
20L ALC 040/CIL	40	ciliegio/cherry wood
20L ALC 040/MIE	40	miele/light brown
20L ALC 040/NOC	40	noce/nutbrown
20L ALC 040/WEN	40	wenghe

48

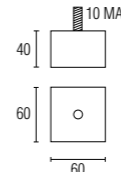

### speedy

LE

Art	H mm	Finitura/Finishing
20L SPE 120/CIL	60	ciliegio/cherry wood
20L SPE 120/MIE	60	miele/light brown
20L SPE 120/NOC	60	noce/nutbrown
20L SPE 120/WEN	60	wenghe

48

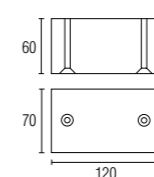

### dakar

LE

Art	H mm	Finitura/Finishing
20L DAK 160/CIL	40	ciliegio/cherry wood
20L DAK 160/MIE	40	miele/light brown
20L DAK 160/NOC	40	noce/nutbrown
20L DAK 160/WEN	40	wenghe

48

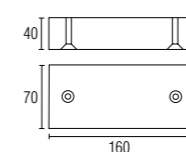

### otranto

LE

Art	H mm	Finitura/Finishing
20L OTR 220/CIL	25	ciliegio/cherry wood
20L OTR 220/MIE	25	miele/light brown
20L OTR 220/NOC	25	noce/nutbrown
20L OTR 220/WEN	25	wenghe

48

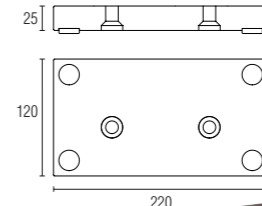

new entry

### houston

● Le/PL

Art	H mm	Finitura/Finishing
20L HOU 035/WEN	35	wenghe - lucido/polished

☐ 24

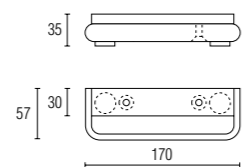

### jersey

● Le/PL

Art	H mm	Wenghe Opaco/Mat	Destro Right	Sinistro Left
20L JE OD215/WE	40	•	•	
20L JE OS215/WE	40	•		•

☐ 24

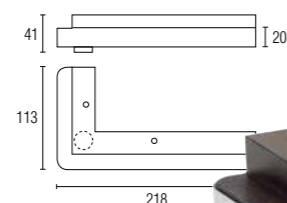

### west

● Le/PL

Art	H mm	Wenghe Lucido/polished	Destro Right	Sinistro Left
20L WE LD265/WE	35	•	•	
20L WE LS265/WE	35	•		•

☐ 24

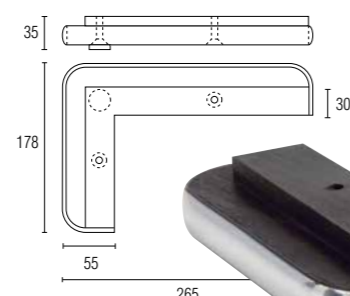

### sud

● Le/PL

Art	H mm	Finitura/Finishing
20L SUD L225/WE	35	wenghe - lucido/polished

☐ 24

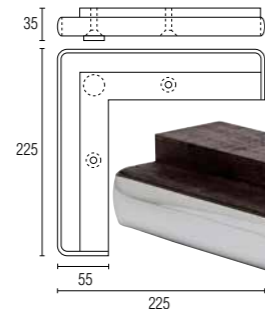

### est

● Le/AL

Art	H mm	Wenghe Lucido/polished	Destro Right	Sinistro Left
20L ESL 5D225/WE	50	•	•	
20L ESL 5S225/WE	50	•		•

☐ 48

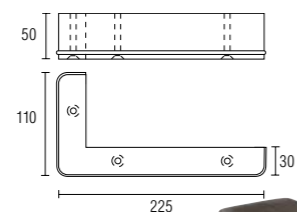

### georgia

● Le/AL

Art	H mm	Finitura/Finishing
20L GEO 195/WEN	65	wenghe - opaco/mat
20L GEO 220/WEN	65	wenghe - opaco/mat

☐ 24

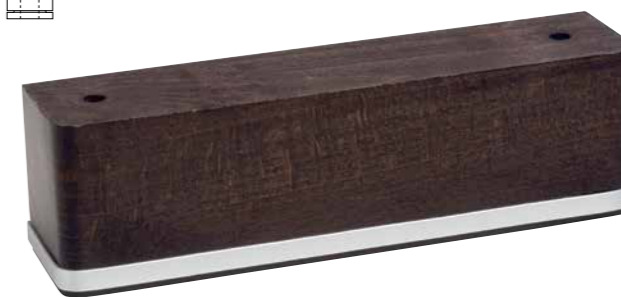
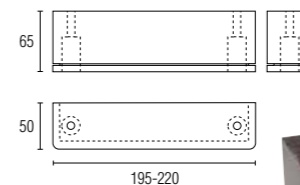

### floor

● Le/AL

Art	H mm	Finitura/Finishing
20L FLO 160/WEN	45	wenghe
20L FLO 200/WEN	45	wenghe

☐ 24

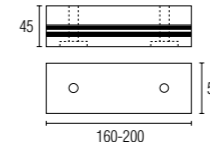

### rettangolo

● Le/AL

Art	H mm	Finitura/Finishing
20L RET 060/CIL	60	ciliegio/cherry wood
20L RET 060/MIE	60	miele/light brown
20L RET 060/NOC	60	noce/nutbrown
20L RET 060/WEN	60	wenghe

+ 20A PIA L120ALT  
☐ 24

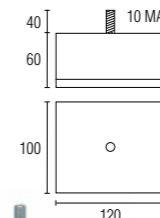

20A PIA L120ALT

20L RET 060/NOC

20L RET 060/NOC + 20A PIA L120ALT



### qui

● Le/AL

Art	H mm	Finitura/Finishing
20L QUI 45/CIL	45	ciliegio/cherry wood
20L QUI 45/MIE	45	miele/light brown
20L QUI 45/NOC	45	noce/nutbrown
20L QUI 45/WEN	45	wenghe

+ 20A PIA L045  
☐ 24

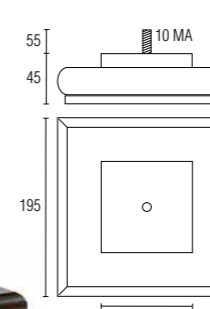

20A PIA L045

20L QUI 45/WEN

20L QUI 45/WEN + 20A PIA L045

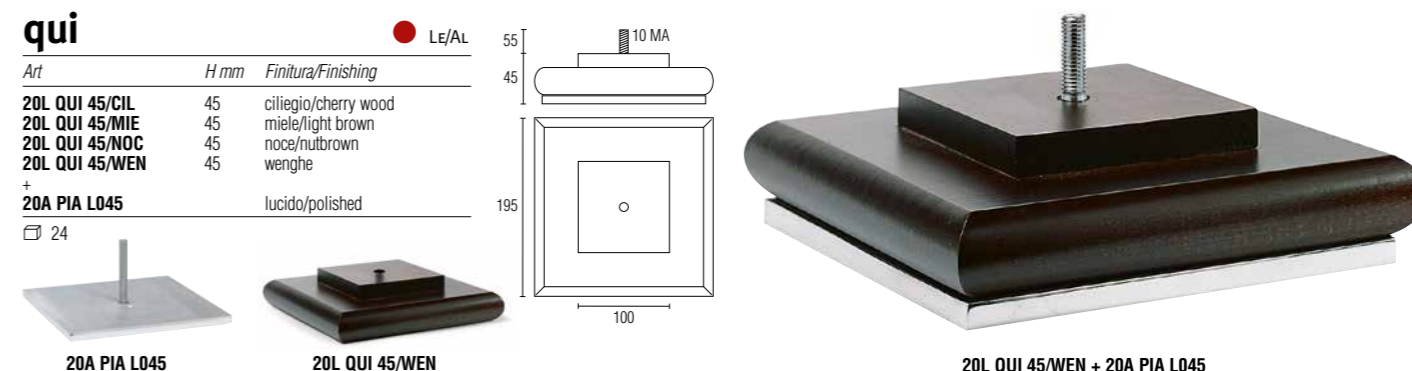

### qua

● Le/AL

Art	H mm	Finitura/Finishing
20L QUA 055/CIL	55	ciliegio/cherry wood
20L QUA 055/MIE	55	miele/light brown
20L QUA 055/NOC	55	noce/nutbrown
20L QUA 055/WEN	55	wenghe

+ 20A PIA L055  
☐ 24

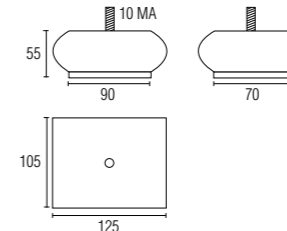

20A PIA L055

20L QUA 055/MIE

20L QUA 055/MIE + 20A PIA L055

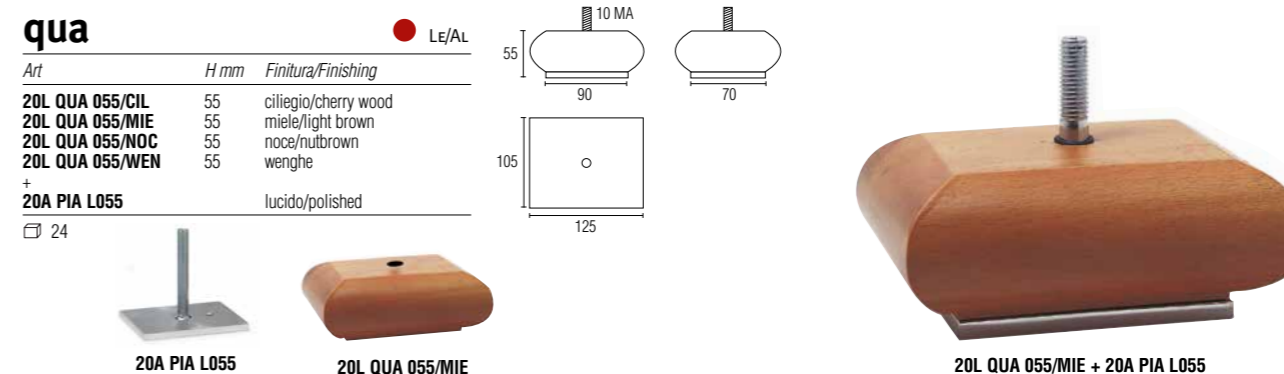

### easy

Art	H mm	ø mm	Vite estraibile Removable screw	Vite fissa Fixed screw	Antiscivolo Antislip	☐
20P E2F	25	60	•	•		550
20P E4E	40	60	•			500
20P E4F	40	60		•		400
20P E4FA	40	60		•	•	400
20P E5E	50	60	•			300
20P E5F	50	60		•		330
20P E5FA	50	60		•	•	330
20P E6E	60	60	•			350
20P E6F	60	60		•		275
20P E6FA	60	60		•	•	275
20P E8E	80	60	•			250
20P E8F	80	60		•		220
20P E10E	100	60	•			200

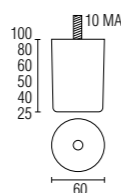

### pqw

Art	H mm	ø mm	Antiscivolo Antislip
20P 140PQW 20	20	60	•
20P 140PQ 30	30	60	
20P 140PQW 30	30	60	•
20P 140PQ 60	60	60	
20P 140PQW 60	60	60	•
20P 140PQ 80	80	60	
20P 140PQW 80	80	60	•
20P 140PQ 105	105	60	
20P 140PQW 105	105	60	•
20P 140PQW150	150	60	•

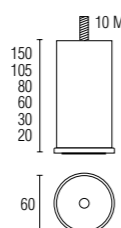

### a55

Art	H mm	ø mm	Vite screw
20P A55 H25M10	25	55	10 ma
20P A55 H30M8	30	55	8 ma
20P A55 H30M10	30	55	10 ma

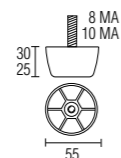

### a60

Art	H mm	ø mm	Vite screw	Sporgenza vite mm Overhang screw mm	☐
20P A60 H40M10	40	60	10 ma	30	400
20P A60 H40M1020	40	60	10 ma	20	400
20P A60 H40M1040	40	60	10 ma	40	400
20P A60 H40M1050	40	60	10 ma	50	400
20P A60 H50M10	50	60	10 ma	30	360
20P A60 H60M8	60	60	8 ma	30	320
20P A60 H60M10	60	60	10 ma	30	320

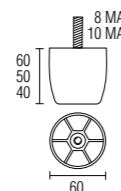

### spillo

Art	H mm	ø mm	☐
20P E9A65	65	25	100
20P E9	80	25	300
20P E10	100	30	300
20P E13	130	30	250
20PT E925BN50	puntale/cap	25	50

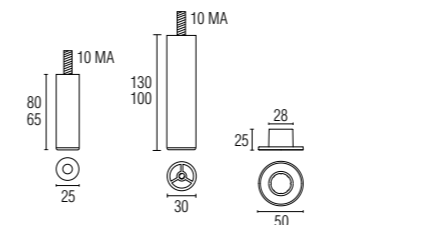

20PT E9 25BN50

Puntale opzionale per art.20PE9  
Optional cap for art.20PE9  
Optionale Kappe für art.20PE9  
Tapón opcional para art.20PE9

### d1

Art	H mm	ø mm
20P D1	25	46

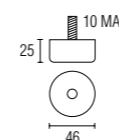

### sm3

Art	H mm	ø mm
20P SM3	30	75

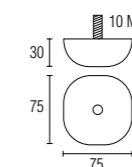

### 117

Art	H mm	ø mm
20P 117 60	60	90

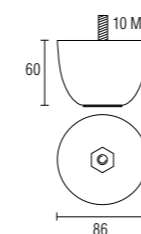

### 031-085

Art	H mm	ø mm	☐
20P 99085035	35	90	185
20P 99031085	50	90	165

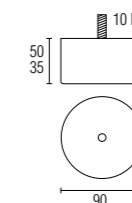

### lh

Art	H mm	ø mm
20P 140LH100	100	75
20P 140LH120	120	75

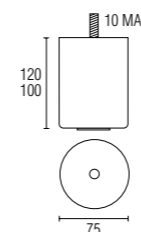

### lr

Art	H mm	ø mm
20P 140LR120	120	75

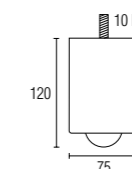

### S140

● PL

Art	H mm	ø mm	Antiscivolo Antislip
20P S140	140	60	
20P S140A	140	60	•

☞ 100

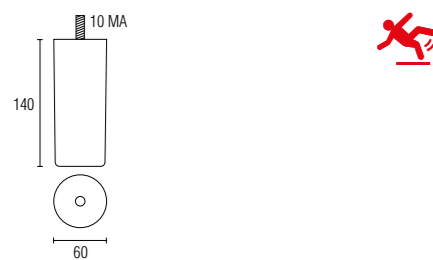

### p120

● PL

Art	H mm	ø mm
20P P120	120	60

☞ 100

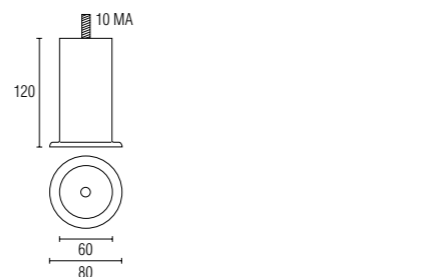

### S200

● PL

Art	H mm	ø mm
20P S200	190	70
20P S209	200	70
20P S215	215	70

☞ 100

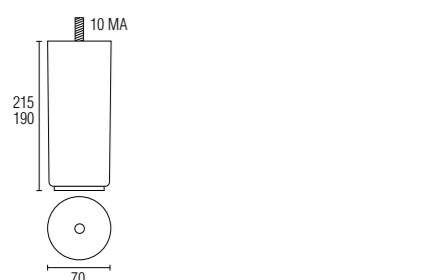

### S220 con ruota

● PL

Art	H mm	ø mm
20P S220	190	70
20P S221	210	70

☞ 100

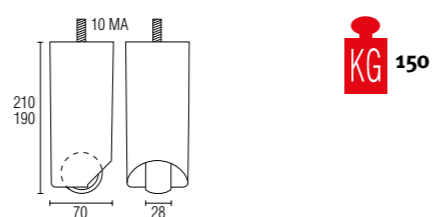

### regolo

● PL

Art	H mm	ø mm
20P REG 100R	100	40

☞ 100

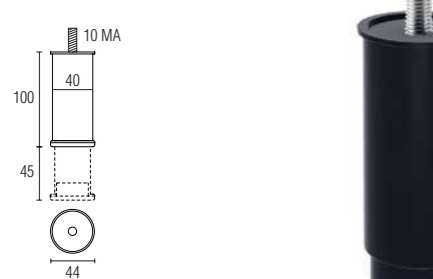

### r169n

● PL

Art	H mm	ø mm
20R 169N	28	56

☞ 100

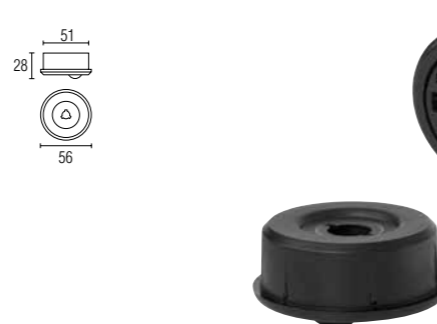

### k autobloccante

● PL

Art	H mm	ø mm
20P K1	60	50
20P K2	50	31
20P K3	55	40

☞ 100

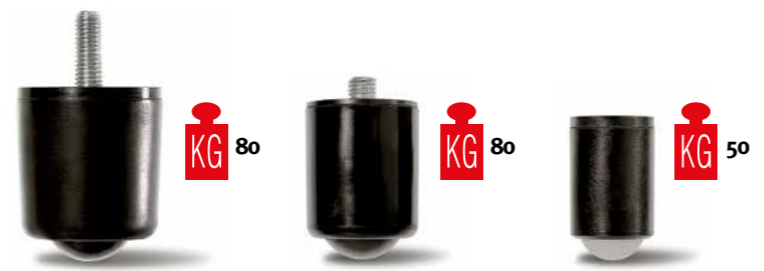
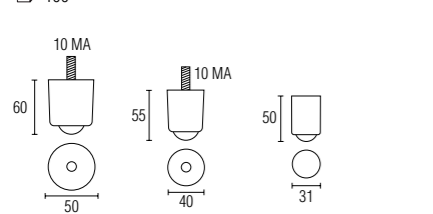

### vite legno a60

● PL

Art	H mm	ø mm
20P A60 H40F	40	60
20P A60 H60F	60	60

☞ 100



### vite legno

● PL

Art	H mm	ø mm
20P H40F	40	60
20P H60F	60	60

☞ 100



### Z1

● PL

Art	H mm	ø mm
20P Z1	25	60
20P Z2	20	50
20P Z3	25	46

☞ 500



### pressione

● PL

Art	H mm	ø mm
20P 48	12	35
20P 49	20	45

☞ 500

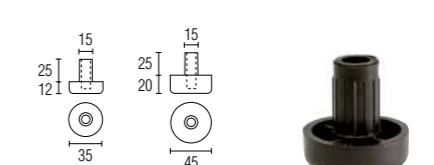

### tm

● PL

Art	H mm	ø mm	☞
20 08 186TM18	12	18	2000
20 08 186TM30	12	30	500

☞ 2000



### piede per chiodo

● PL

Art	H mm	ø mm
20P CON 12	12	29

☞ 100

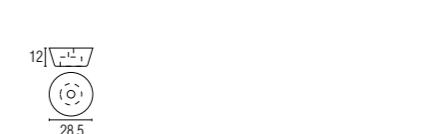

### rettangolare

● PL

Art	H mm
20P R	20

☞ 500

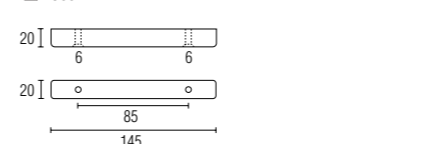

### angolare

● PL

Art	H mm
20P 384035	35

☞ 500

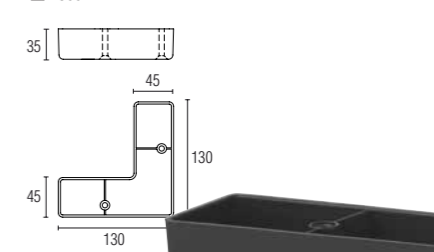

### margot

● AL

Art	L mm	H mm	Finitura Finishing
22A MAR GL0830S	830	145	lucido/polished
22A MAR GO0830S	830	145	opaco/mat

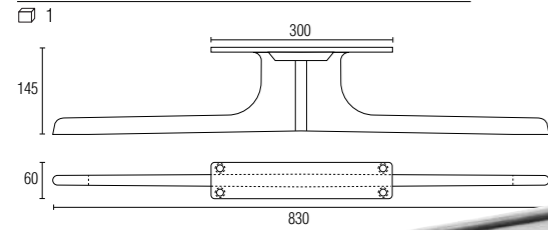

### margot 1

● AL

Art	L mm	H mm	Finitura Finishing
22A MARG1L0415S	415	145	lucido/polished
22A MARG1O0415S	415	145	opaco/mat

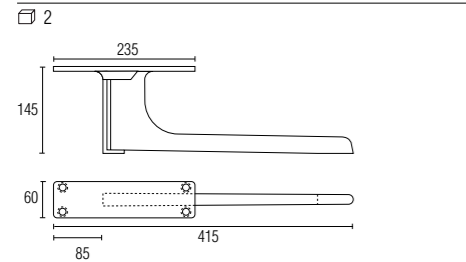

### martin

● AL

Art	L mm	H mm	Finitura Finishing
22A MART L0770S	770	150	lucido/polished
22A MART O0770S	770	150	opaco/mat

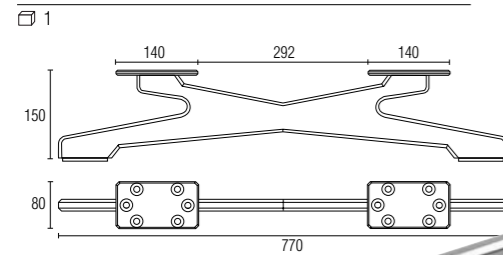

### marvin

● FE

Art	L mm	H mm	Finitura Finishing
22F MARV C680T	680	145	cromato/chromed
22F MARV C880T	880	145	cromato/chromed

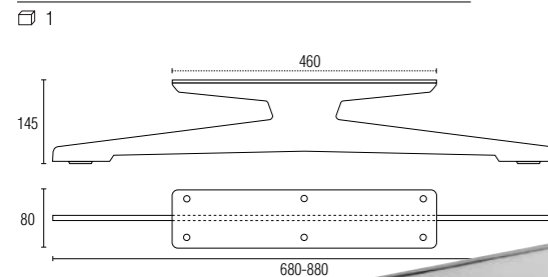

### mary

● FE

Art	L mm	H mm	Finitura Finishing
22F MARY C875T	875	145	cromato/chromed

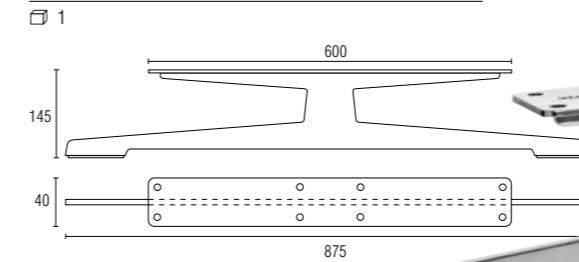

### panca

● FE

Art	L mm	H mm	Finitura Finishing
22F PAN C0890Z	890	120	cromato/chromed
22F PAN C1040Z	1040	120	cromato/chromed

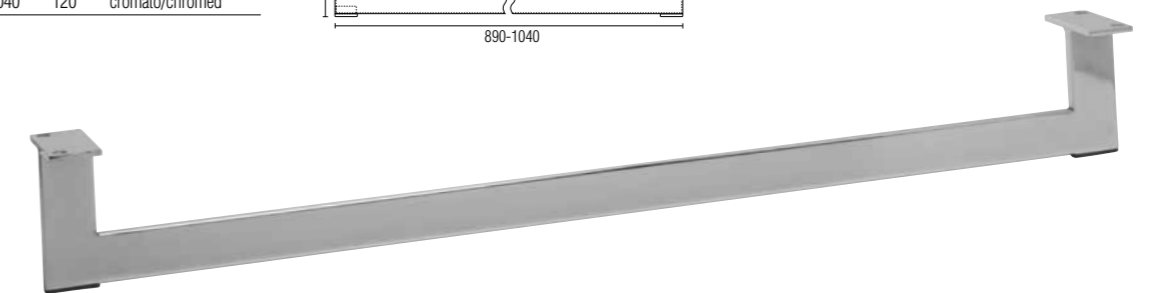
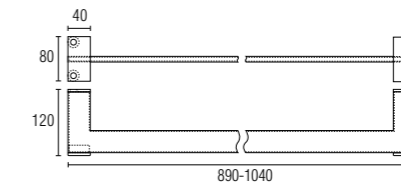

### nick

● AL

Art	L mm	H mm	Finitura Finishing
22A NICK2 L770F	770	147	lucido/polished
22A NICK2 O770F	770	147	opaco/mat
22A NICK2 L890F	890	147	lucido/polished
22A NICK2 O890F	890	147	opaco/mat
22A NICK2 L980F	980	147	lucido/polished
22A NICK2 O980F	980	147	opaco/mat
20A NICK L147	-	147	lucido/polished
20A NICK O147	-	147	opaco/mat

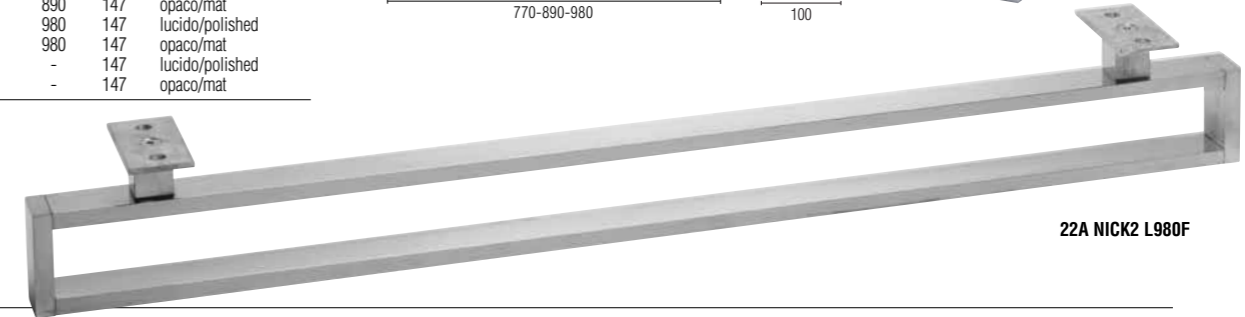
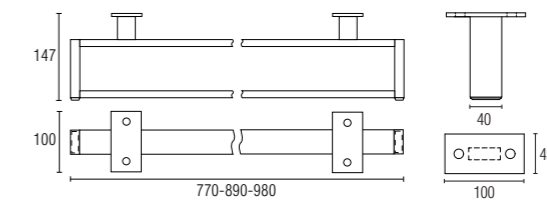

### new york

● FE

Art	L mm	H mm	Finitura Finishing
22F NEW C880Z	880	140	cromato/chromed

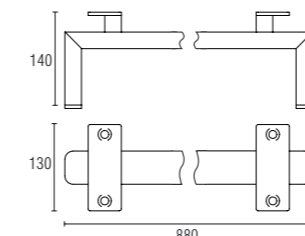

## magic

● AL

Art	L mm	H mm	Finitura Finishing
22A90 MAG L080	800	210	lucido/polished
22A90 MAG L090	900	210	lucido/polished

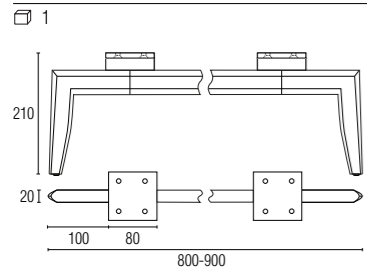

## silvan

● AL

Art	L mm	H mm	Finitura Finishing
22A SIL L800	800	200	lucido/polished
20A SIL1 L200	-	200	lucido/polished

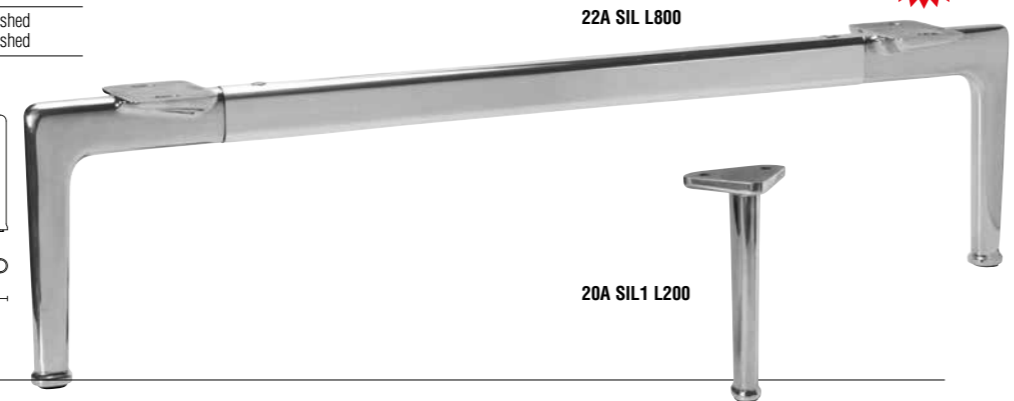
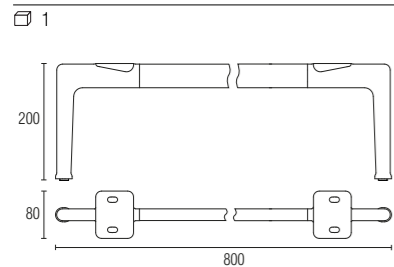

new entry

## carlo

● AL

Art	L mm	H mm	Finitura Finishing
22A CAR VL830S-NT	830	160	VL-NT nero titanio/black titanium
22A CAR VL880S-NT	880	160	VL-NT nero titanio/black titanium
20A CA VL160S-NT	-	160	VL-NT nero titanio/black titanium

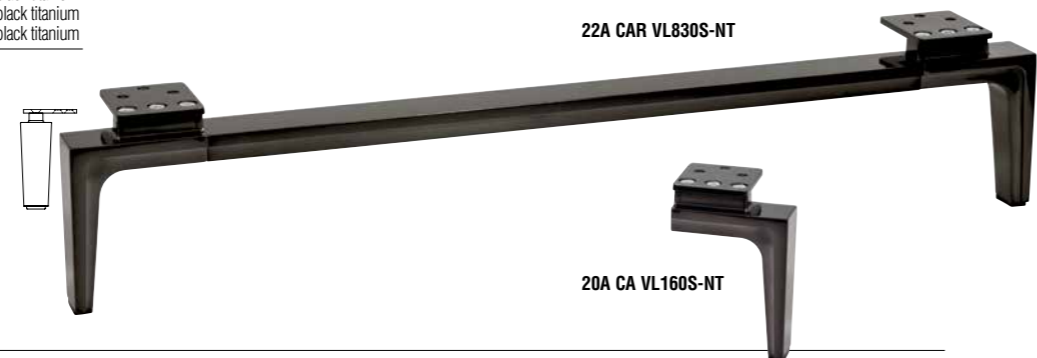
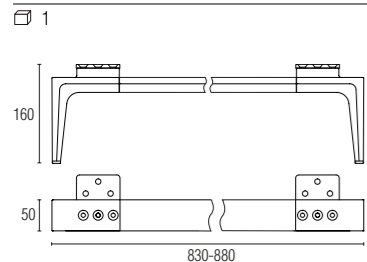

new entry

## diana

● AL

Art	L mm	H mm	Finitura Finishing
22A DIA GA830S_NN	830	140	GA-NN nickel nero/black nickel
22A DIA GA900S_NN	900	140	GA-NN nickel nero/black nickel

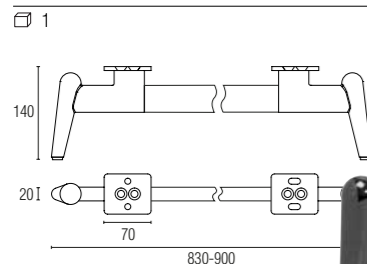

new entry

## casinò

● AL

Art	L mm	H mm	Finitura Finishing
22A CAS L980	980	138	lucido/polished
22A CAS 0980	980	138	opaco/mat

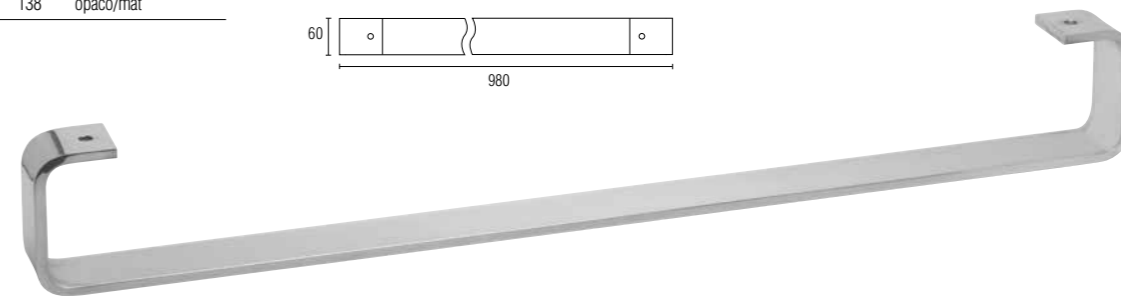
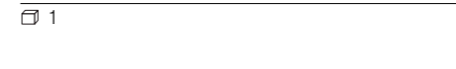

## 2225

● AL

Art	L mm	H mm	Finitura Finishing
22A90 2225 L13	857	130	lucido/polished
22A90 2225 013	857	130	opaco/mat

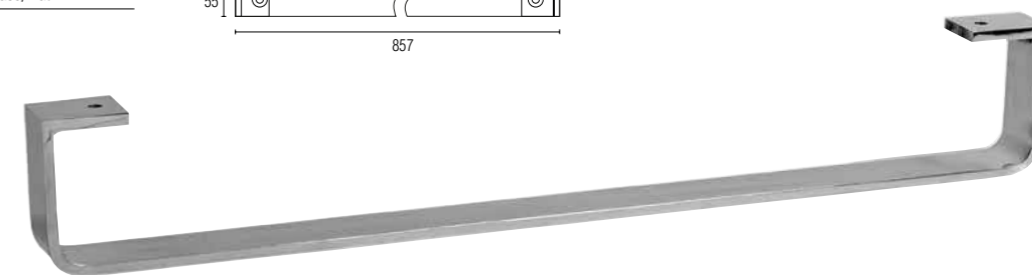

## calais

● AL

Art	L mm	H mm	Finitura Finishing
22F CAL1 C875	875	170	cromato/chromed
32F CAL1 VP875/50L	875	170	VP-50L - nero/black

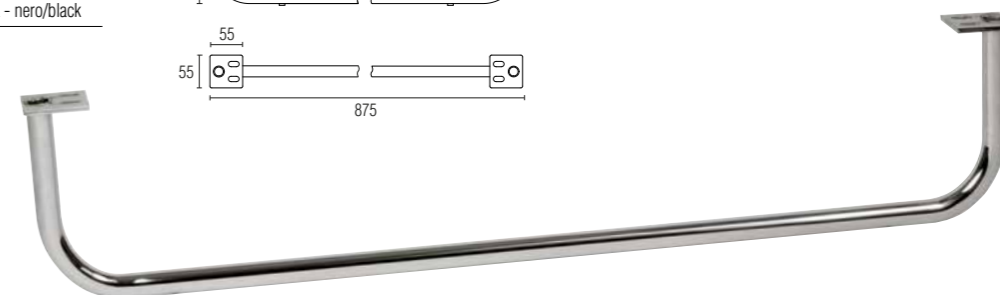

## pmf

● FE

Art	∅ mm	L mm	H mm	Finitura/Finishing
24F PMF C140	25	100x100	140	cromato/chromed
24F PMF C550 PRO	25	550	-	cromato/chromed
24F PMF C730 PRO	25	730	-	cromato/chromed
24F PMF C770 PRO	25	770	-	cromato/chromed
24F PMF C160 PRO	25	1600	-	cromato/chromed
24F PMF C180 PRO	25	1800	-	cromato/chromed
24F PMF C120 PRO	25	2000	-	cromato/chromed

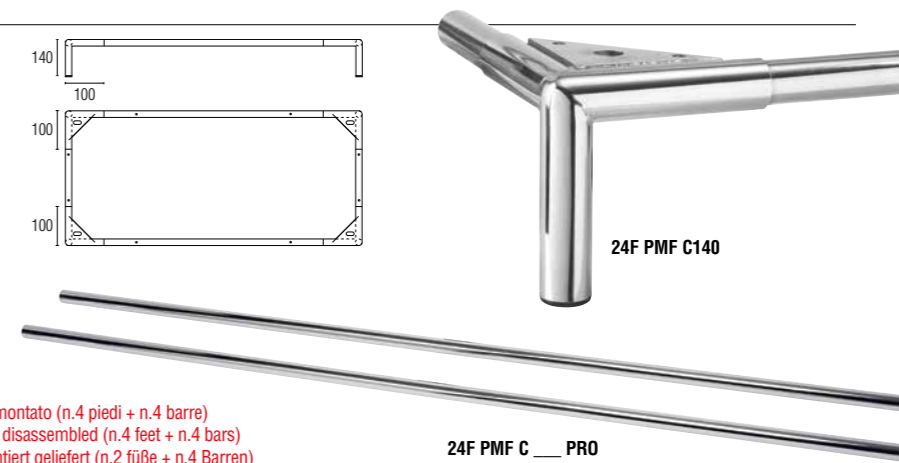
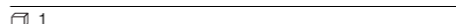

Misure speciali su richiesta  
On request special measurements  
Verfügbar auf Wunsch mit speziellen maßen  
Disponible segun pedido medidas especiales

Telaio fornito smontato (n.4 piedi + n.4 barre)  
Frame supplied disassembled (n.4 feet + n.4 bars)  
Rahmen demontiert geliefert (n.2 füße + n.4 Barren)  
Estructura suministrado desmontado (n.2 patas + n.4 barras)

24F PMF C \_\_\_ PRO

### jo8

Art	∅ mm	H mm	Finitura Finishing
23BF JO8 L5512S	550	120	lucido/polished
23BF JO8 L5520S	550	200	lucido/polished
23BF JO8 S5520S	550	200	satinato/satin
23BF JO8 L5030S	500	300	lucido/polished
23BF JO8 S5030S	500	300	satinato/satin

☐ 1

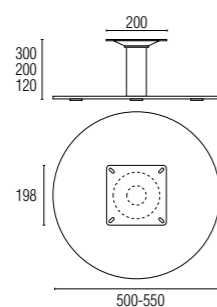

### plat

Art	∅ mm	H mm	Ritorno autom. Automatic return	Finitura Finishing
23BF PLA C120G	540	120		cromato/chromed
23BF PLA S120G	540	120		satinato/satin
23BF PLA C150G	540	150		cromato/chromed
23BF PLA S150G	540	150		satinato/satin
23BF PLA C175GR	540	175	•	cromato/chromed
23BF PLA S175GR	540	175	•	satinato/satin
23BF PLA C621GR	600	210	•	cromato/chromed
23BF PLA S621GR	600	210	•	satinato/satin

☐ 1

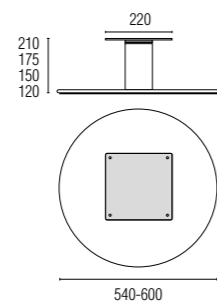

### jo1

Art	∅ mm	H mm	Finitura Finishing
23BF JO1 C6018S	500	180	cromato/chromed
23BF JO1 C6018S	600	180	cromato/chromed

☐ 1

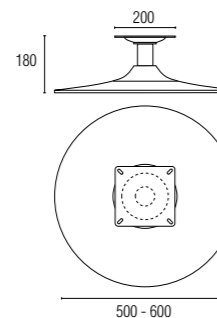

### cono

Art	∅ mm	H mm	Finitura Finishing
23B FCON L120G	600	120	lucido/polished

☐ 1

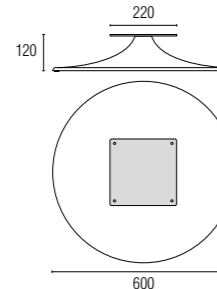

### pongo

Art	L mm	H mm	Finitura Finishing
23BF PON NC550G	550	150	lucido/polished
23BF PON NS550G	550	150	satinato/satin

☐ 1

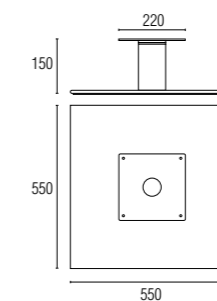

### nico 4 razze

Art	∅ mm	H mm	Finitura Finishing
23BF NI4 C63150G	630	150	cromato/chromed
23BF NI4 S63150G	630	150	satinato/satin
23BF NI4 C63190G	630	190	cromato/chromed
23BF NI4 S63190G	630	190	satinato/satin

☐ 1

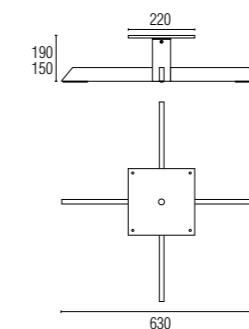

### nico 5 razze

Art	∅ mm	H mm	Finitura Finishing
23BF NI5 C60155G	600	155	cromato/chromed
23BF NI5 S60155G	600	155	satinato/satin
23BF NI5 C60190G	600	190	cromato/chromed
23BF NI5 S60190G	600	190	satinato/satin

☐ 1

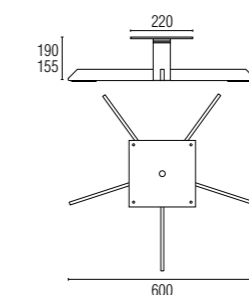

### luna

Art	∅ mm	H mm	Finitura Finishing
23BF LUN C720G	720	185	cromato/chromed

☐ 1

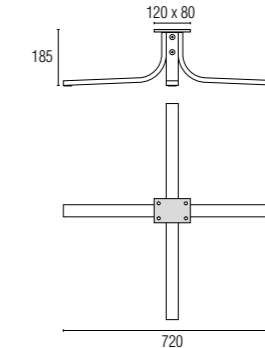



### cross 4 razze

● FE

Art	∅ mm	H mm	Finitura Finishing
23BF CRO C690G	690	200	cromata/chromed
23BF CRO NN690G	690	200	GA-NN nickel nero/black nickel

☐ 1

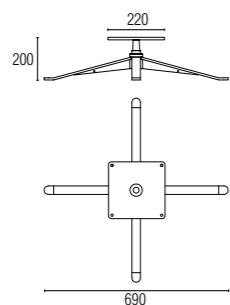

### cross 5 razze

● FE

Art	∅ mm	H mm	Finitura Finishing
23BF CR5 C690GS	690	200	cromata/chromed

☐ 1

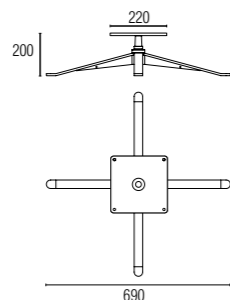

### h03

● FE

Art	∅ mm	H mm	Finitura Finishing
23BF H03 C6520S	650	200	cromata/chromed
23BF H03 NN7020S	700	200	GA-NN nickel nero/black nickel

☐ 1

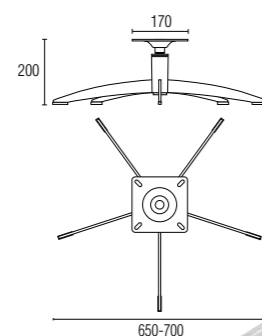

### ragno

● AL

Art	∅ mm	H mm	Finitura Finishing
23BA RAG L700GG	700	300-360	lucido/polished

☐ 1

Puntali o ruote a parte / Caps or wheels separately  
Gleiter oder Rad separat / Tapon o rueda por separado

Art	Tipo Type	H mm
20PT RAGNO	puntale/cap	15
20R RAGNO	ruota/wheel	60

☐ 50

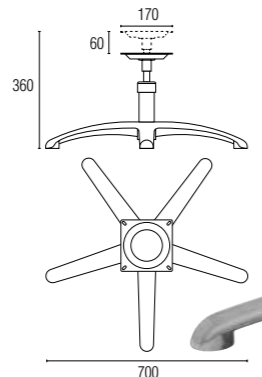

Regolabile  
adjustable  
verstellbar  
regulable



### romagna

● AL

Art	∅ mm	H mm	Ritorno autom. Automatic return	Finitura Finishing
23BA ROM L8225G	820	250		lucido/polished
23BA ROM L8225R	820	250	•	lucido/polished

☐ 1

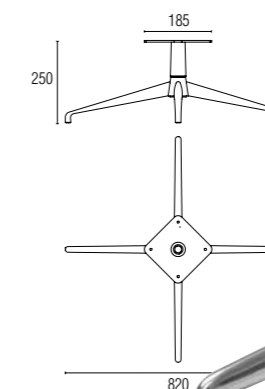

new  
entry

### romagna alta

● AL

Art	∅ mm	H mm	Ritorno autom. Automatic return	Finitura Finishing
23BA ROM1 L7030G	700	300		lucido/polished
23BA ROM1 L7030R	700	300	•	lucido/polished
23BA ROM1 L7030F	700	300	fissa/fixed	lucido/polished

☐ 1

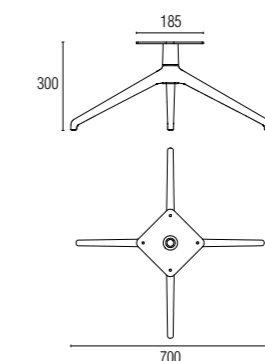

new  
entry

### veneto

● AL

Art	∅ mm	H mm	Ritorno autom. Automatic return	Finitura Finishing
23BA VEN L7123G	710	180		lucido/polished
23BA VEN L7123R	710	180	•	lucido/polished

☐ 1

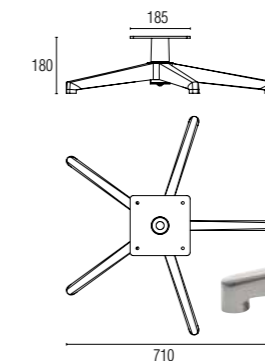

new  
entry

### lombardia

● AL

Art	∅ mm	H mm	Ritorno autom. Automatic return	Finitura Finishing
23BA LOM L7121G	710	210		lucido/polished
23BA LOM L7121R	710	210	•	lucido/polished

☐ 1

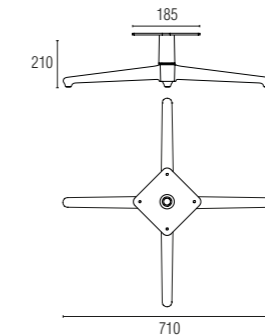

new  
entry

## sky

Art	∅ mm	H mm	Ritorno autom. Automatic return	Finitura Finishing
23BA SKY L660G	660	185		lucido/polished
23BA SKY L660R	660	185	•	lucido/polished
23BA SKY O660G	660	185		opaco/mat
23BA SKY O660R	660	185	•	opaco/mat

☐ 1



## star

Art	∅ mm	H mm	Ritorno autom. Automatic return	Finitura Finishing
23BA STA L660G	660	260		lucido/polished
23BA STA L660R	660	260	•	lucido/polished
23BA STA O660G	660	260		opaco/mat
23BA STA O660R	660	260	•	opaco/mat
33BA STA VP660G/50L	660	260		VP-50L nero/black

☐ 1



## timone

Art	∅ mm	H mm	Finitura/Finishing
23BAE TIM L7022GS	700	200	lucido/polished

☐ 1



new entry

## ancora

Art	∅ mm	H mm	Finitura Finishing
23BAE ANC L6820GS	680	200	lucido/polished

☐ 1



new entry

## arpione

Art	∅ mm	H mm	Finitura Finishing
23BAE ARP L7020GS	700	200	lucido/polished

☐ 1



new entry

## elica

Art	∅ mm	H mm	Finitura Finishing
23BAE ELI L8020GS	800	200	lucido/polished

☐ 1



new entry

## navy

Art	∅ mm	H mm	Finitura Finishing
23BF NAV NS6536GS	650	360	satinato/satin
33BF NAV VP6536GS/50	650	360	VP-50 nero/black

☐ 1



new entry

## swivel

Art	∅ inch	∅ mm
23BF WHE V610GS	24	610
23BF WHE V850GS	34	850

☐ 1



Swivel fornito smontato  
Swivel supplied disassembled  
Swivel demontiert geliefert  
Swivel suministrado desmontado

### rsa 10

Art	H mm	Vite Screw	Piastra Plate	Freno Brake	Forcella structure	Ruota Wheel
20R SA10 C	100	10 ma				
20R SA10 N	100	10 ma				
20R SA10 VC	100	10 ma				
20R SA10P C	100		•			
20R SA10P N	100		•			
20R SA10P VC	100		•			

48

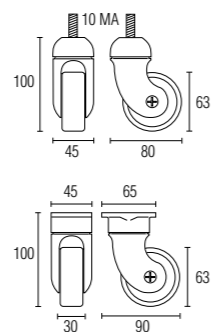

20R SA10P C



KG 130

### rsa 12

Art	H mm	Vite Screw	Piastra Plate	Freno Brake	Forcella structure	Ruota Wheel
20R SA12 C	120	10 ma				
20R SA12 N	120	10 ma				
20R SA12 VC	120	10 ma				
20R SA12P C	120		•			
20R SA12P N	120		•			
20R SA12P VC	120		•			
20R SA12F C	120	10 ma		•		
20R SA12F N	120	10 ma		•		
20R SA12F VC	120	10 ma		•		
20R SA12FP C	120		•	•		
20R SA12FP N	120		•	•		
20R SA12FP VC	120		•	•		

48

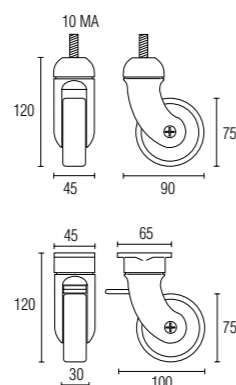

20R SA12F C



KG 130

### rsa 13

Art	H mm	Vite Screw	Piastra Plate	Freno Brake	Forcella structure	Ruota Wheel
20R SA13 C	130	10 ma				
20R SA13 N	130	10 ma				
20R SA13 VC	130	10 ma				
20R SA13P C	130		•			
20R SA13P N	130		•			
20R SA13P VC	130		•			
20R SA13P VN	130		•			
20R SA13F C	130	10 ma		•		
20R SA13F N	130	10 ma		•		
20R SA13F VC	130	10 ma		•		
20R SA13FP C	130		•	•		
20R SA13FP N	130		•	•		
20R SA13FP VC	130		•	•		
20R SA13FP VN	130		•	•		

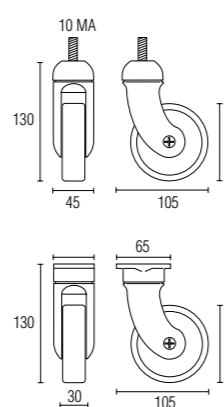

48



20R SA13P VC



KG 130

-  Cromato/chromed
-  Nero/Black
-  Verniciato/Laquered

### rsa 18

Art	H mm	Vite Screw	Piastra Plate	Freno Brake	Forcella structure	Ruota Wheel	Pivoettante Pivoting	Unidirezionale Unidirectional
20R SA18 C	180	10 ma					•	
20R SA18 N	180	10 ma					•	
20R SA18 VC	180	10 ma					•	
20R SA18P C	180		•				•	
20R SA18P N	180		•				•	
20R SA18P VC	180		•				•	
20R SA18F C	180	10 ma		•			•	
20R SA18F N	180	10 ma		•			•	
20R SA18F VC	180	10 ma		•			•	
20R SA18FP C	180		•	•			•	
20R SA18FP N	180		•	•			•	
20R SA18FP VC	180		•	•			•	
20R SA18U C	180	10 ma						•
20R SA18U N	180	10 ma						•
20R SA18U VC	180	10 ma						•
20R SA18UF C	180	10 ma		•				•
20R SA18UF N	180	10 ma		•				•
20R SA18UF VC	180	10 ma		•				•

48

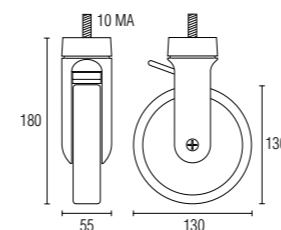

20R SA18F VC

Pivoettante  
Pivoting  
Auf Pivot  
Giratoria



KG 130

### rsa 22

Art	H mm	Vite Screw	Piastra Plate	Freno Brake	Forcella structure	Ruota Wheel	Pivoettante Pivoting	Unidirezionale Unidirectional
20R SA22 C	220	10 ma						•
20R SA22 N	220	10 ma						•
20R SA22P VC	220	10 ma						•
20R SA22P C	220		•					•
20R SA22P N	220		•					•
20R SA22 VC	220		•					•
20R SA22F C	220	10 ma		•				•
20R SA22F N	220	10 ma		•				•
20R SA22F VC	220	10 ma		•				•
20R SA22FP C	220		•	•				•
20R SA22FP N	220		•	•				•
20R SA22FP VC	220		•	•				•
20R SA22U C	220	10 ma						•
20R SA22U N	220	10 ma						•
20R SA22U VC	220	10 ma						•
20R SA22UF C	220	10 ma		•				•
20R SA22UF N	220	10 ma		•				•
20R SA22UF VC	220	10 ma		•				•

48

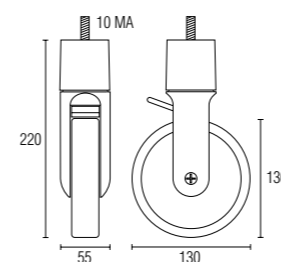

20R SA22U VC

Unidirezionale  
Unidirectional  
Unidirektional  
Unidireccional



KG 130

### blitz

Art	H mm	Finitura/Finishing
20R H08PK1V1AG	80	crom/all/vite/gomma grigia
20R H08PK3V1NN	80	nera/nera/vite/gomma nera
20R H12PK2V1NN	120	all/nera/vite/gomma nera
20R H12PK3V1NN	120	nera/nera/vite/gomma nera

☐ 48



KG 35

### tube

Art	H mm	Vite Screw	Freno Brake	Forcella structure	Ruota Wheel	Pivoettante Pivoting
20R M10GPBVOB	100	10 ma				•
20R M10PGVOG	100	10 ma				•
20R M12GPBVOB	120	10 ma				•
20R M12PGVOG	120	10 ma				•

☐ 24

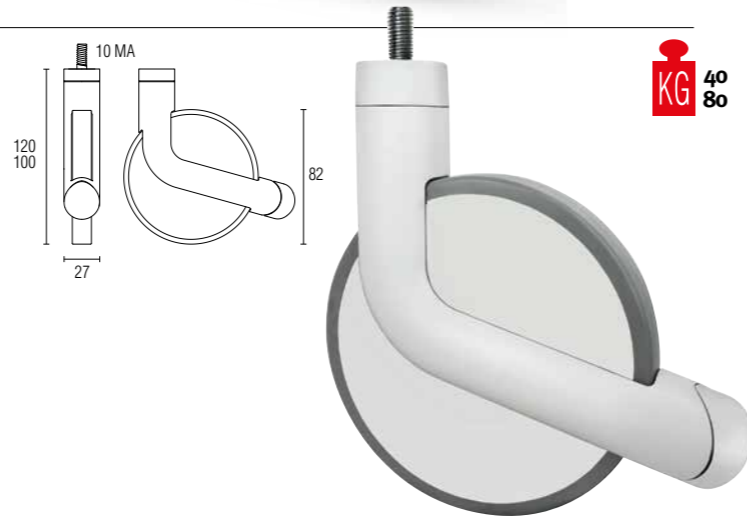

KG 40

### yin

Art	H mm	Finitura/Finishing
20R YIL110	110	• lucido/polished
20R YIS110	110	• opaco/mat
20R YIL130	130	• lucido/polished
20R YIS130	130	• opaco/mat
20R YIL110P	110	• lucido/polished
20R YIS110P	110	• opaco/mat
20R YIL130P	130	• lucido/polished
20R YIS130P	130	• opaco/mat

☐ 48



KG 180

### yang

Art	H mm	Finitura/Finishing
20R YAL160	160	• lucido/polished
20R YAS160	160	• opaco/mat
20R YAL180	180	• lucido/polished
20R YAS180	180	• opaco/mat
20R YAL160P	160	• lucido/polished
20R YAS160P	160	• opaco/mat
20R YAL180P	180	• lucido/polished
20R YAS180P	180	• opaco/mat

☐ 48



KG 180

### cargo

Art	H mm	Vite Screw	Piastra Plate	Freno Brake	Forcella structure	Ruota Wheel
20R SB10 C	100	•				
20R SB10 N	100	•				
20R SB10 VC	100	•				
20R SB10P C	100		•			
20R SB10P N	100		•			
20R SB10P VC	100		•			
20R SB10F C	100	•		•		
20R SB10F N	100	•		•		
20R SB10F VC	100	•		•		
20R SB10FP C	100		•	•		
20R SB10FP N	100		•	•		
20R SB10FP VC	100		•	•		
20R SB15 C	150	•				
20R SB15 N	150	•				
20R SB15 VC	150	•				
20R SB15P C	150		•			
20R SB15P N	150		•			
20R SB15P VC	150		•			
20R SB15F C	150	•		•		
20R SB15F N	150	•		•		
20R SB15F VC	150	•		•		
20R SB15FP C	150		•	•		
20R SB15FP N	150		•	•		
20R SB15FP VC	150		•	•		

☐ 48

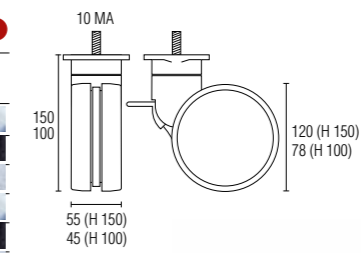

KG 130



### pivoettante

Art	H mm	Vite Screw	Ø mm	Piastra Plate	Freno Brake
20R PIV	120	10 ma	75		•

☐ 72

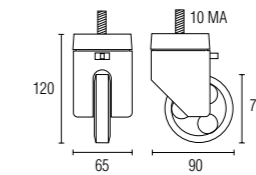

KG 60



### gemellata

Art	H mm	Vite Screw	Ø mm	Piastra Plate	Freno Brake
20R 680	85	10 ma	80		•

☐ 72

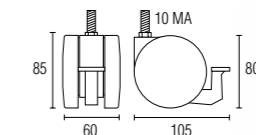

KG 60



### doppia

Art	H mm	Vite Screw	Ø mm
20R 150R08	64	8 ma	50
20R 150R	64	10 ma	50

☐ 50

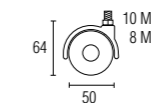

KG 50



### industriali

Art	H mm	Vite Screw	Ø mm	Piastra Plate	Freno Brake
20R 160BIS	60	10 ma	50		
20R 160BISP	60		50	•	
20R 160BISF	60	10 ma	50		•
20R 160BISFP	60		50	•	•

☐ 50

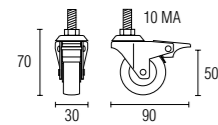

**KG** 40

Art	H mm	Vite Screw	Ø mm	Piastra Plate	Freno Brake
20R 60LVL	85	10 ma	60		
20R 60LVLP	85		60	•	

☐ 50

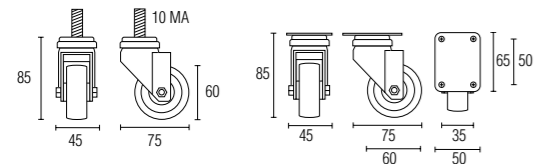

**KG** 40

Art	H mm	Vite Screw	Ø mm	Piastra Plate	Freno Brake
20R 60LVLFD	80	10 ma	60		•

☐ 50

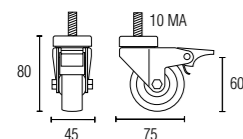

**KG** 40

Art	H mm	Vite Screw	Ø mm	Piastra Plate	Freno Brake
20R 80V4FD	120	10 ma	80		•

☐ 50

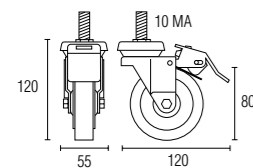

**KG** 50

### pretty

Art	Finitura Finishing	Destro Right	Sinistro Left	H mm
20R PRE C50DXS	cromata/chromed	•		60
20R PRE C50SXS	cromata/chromed		•	60
30R PRE VP50DXS/50	nera/black	•		60
30R PRE VP50SXS/50	nera/black		•	60

☐ 100

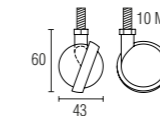

### rop

Art	H mm	Finitura/Finishing
20R ROP	50	Ottone/Brass
20R RAP	50	Argento/Silver
20R RBP	50	Bronzo/Bronze

☐ 25

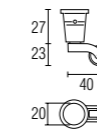

### rom

Art	H mm	Finitura/Finishing
20R ROM	68	Ottone/Brass
20R RAM	68	Argento/Silver
20R RFM	68	Canna di fucile/Dark gray
20R RBM	68	Bronzo/Bronze

☐ 25



### rog

Art	H mm	Finitura/Finishing
20R ROG	86	Ottone/Brass
20R RAG	86	Argento/Silver
20R RFG	86	Canna di fucile
20R RBG	86	Bronzo/Bronze

☐ 25

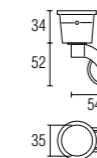

**o-ring** ● OT

Art	H mm	Finitura/Finishing
20R ROPG	50	Ottone/Brass
20R ROMG	67	Ottone/Brass
20R ROGG	86	Ottone/Brass

☐ 25



**rq** ● OT

Art	H mm	Finitura/Finishing
20R RQ	72	Ottone/Brass
20R RAQ	72	Argento/Silver
20R RCQ	72	Canna di fucile/Dark gray
20R RBQ	72	Bronzo/Bronze

☐ 25

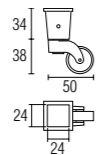

**bicchiere** ● OT

Art	H mm	Finitura/Finishing
20R RBOP	30	Ottone/Brass
20R RBOM	35	Ottone/Brass
20R RBOG	40	Ottone/Brass
20R RBAP	30	Argento/Silver
20R RBAM	35	Argento/Silver
20R RBAG	40	Argento/Silver

☐ 50



**bicchiere quadro** ● OT

Art	H mm	Finitura/Finishing
20R RBOQ	37	Ottone/Brass
20R RBAQ	37	Argento/Silver

☐ 50



**puntale** ● OT

Art	H mm	ø mm	Finitura/Finishing
20R PO	15	25	Ottone/Brass
20R PA	15	25	Argento/Silver

☐ 50



**piattello pa** AL

Art	ø mm	Vite/Screw
20A PA	80	8 mm

☐ 100



**piattelli** AL

Art	H mm	Finitura/Finishing
20A BASE 090L	15	lucido/polished
20A BASE 090O	15	opaco/mat

☐ 100



AL

Art	H mm	Finitura/Finishing
20A TAPPO 070L	13	lucido/polished
20A TAPPO 070O	13	opaco/mat

☐ 100



**piastra tum** AL

Art	H mm	Finitura/Finishing
20A TUM L70X10	10	lucido/polished
20A TUM O70X10	10	opaco/mat

☐ 100

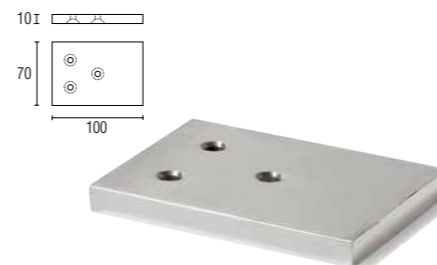

**piattello pb** AL

Art	ø mm	Vite/Screw
20A PB	60	8 ma

☐ 100



AL

Art	H mm	Finitura/Finishing
20A BASE 1562L	8	lucido/polished
20A BASE 1562O	8	opaco/mat

☐ 100



AL

Art	H mm	Finitura/Finishing
20A BASE 060L	13	lucido/polished
20A BASE 060O	13	opaco/mat

☐ 100



**piastra fast** AL

Art	H mm	Finitura/Finishing
20A FAS L45	6,5	lucido/polished
20A FAS O45	6,5	opaco/mat

☐ 100

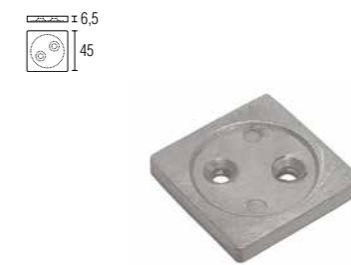

**piattello mobile** AL

Art	ø mm	Vite/Screw
20A PS 35	35	10 ma
20A PS 50	50	10 ma

☐ 500



AL

Art	H mm	Finitura/Finishing
20A PIAT 0553L	6	lucido/polished
20A PIAT 0553O	6	opaco/mat

☐ 100



AL

Art	H mm	Finitura/Finishing
20A PIAT 070L	6	lucido/polished
20A PIAT 070O	6	opaco/mat

☐ 100

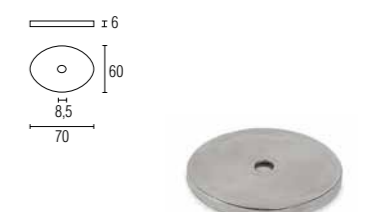

**rondella zincata**

Art	ø mm	D1	☐
16 ROND 6X18	6	18	kg 25
16 ROND 8X24	8	24	kg 25
16 ROND 8X32Z02	8	32	2500 pcs
16 ROND 10X30	10	30	kg 25

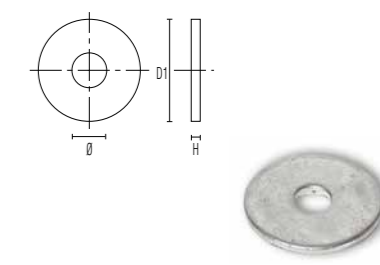

### disco zigrinato

Art	ø mm
2008186D	50
☑ 500	

Disco zigrinato per fissaggio piedini  
Knurledplate for foot fastening  
Randelscheibe zur Befestigung von Füßen  
Disco estriado para fijar patas

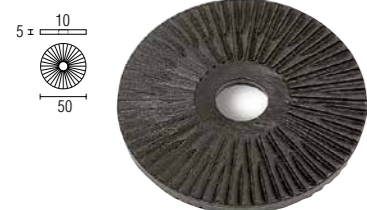

### fondelli 3 fori

Art	Vite/Screw
1608253F06	6 ma
1608253F08	8 ma
1608253F10	10 ma
☑ 1000	

Fondelli 3 fori  
Base with 3 holes  
Boden mit 3 Löchern  
Bottom 3 holes



### millerighe

Art	ø mm
2008186G25	25
2008186G30	30
2008186G35	35
2008186G45	45
2008186G50	50
2008186G70	70
☑ 100	

Gommini millerighe adesivi  
Adhesive scratched rubber  
Selbstklebende geritzte Gummipolster  
Goma adhesiva rayada



### distanziali

Art	mm
2008186TP	220x60
☑ 48	

Distanziali per componibili in plastica  
Plastic spacer for sectional elements  
Abstandsstück aus Plastik  
Für zusammenstellbare Möbel  
Espaciadores para ensamblajes de plastico



### puntale wood

Art	ø mm
20PTWOOD3506	25
☑ 500	

Puntale con foro 6 mm per piedi in legno  
Plastic tip with hole 6 mm for wooden feet  
Tipp mit Loch 6 mm für Holzfüße  
Tapón con agujero de 6 mm para pies de madera



### fondelli ragno

Art	Vite/Screw
160825306	6 ma
160825308	8 ma
160825310	10 ma
☑ 1000	

Dadi Sicur a 4 punte  
Sicur nuts with 4 points  
Sicur Muttern mit 4 Spitzen  
Tuercas Sicur de 4 puntas



### bussole ferro

Art	Vite/Screw
16BUSE10X20SX	10 ma
☑ 1000	

Bussole per piedini in ferro  
Iron compasses for feet  
isenbuhsen für füße  
Coijnete para patas metallicos



### feltro adesivo

Art	ø mm
2008186F20	20
2008186F25	25
2008186F30	30
2008186F35	35
2008186F45	45
2008186F50	50
2008186F70	70
☑ 100	

Feltrini adesivi  
Adhesive felts  
Selbstklebende felt  
Feltro adhesivo

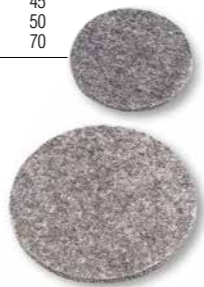

### distanziali

Art	mm
2008186TOM	210x65
☑ 100	

Distanziali regolabili per componibili  
Adjustable spacer for sectional elements  
Abstandsregler Für zusammenstellbare Möbel  
Espaciadores regulables para ensamblajes



### bicchiere antigraffio

Art	ø mm
08012CUP45C	45
08012CUP45DW	45
☑ 100	

Bicchieri antigraffio  
Scratch protection glass  
Kratzschutz Glas  
Filtro con vaso



08012CUP45C

08012CUP45DW

### piattello antiscivolo

Art	ø mm
08012AS54M	54
08012AS54N	54
☑ 100	

Piattello antiscivolo gomma  
Rubber Antislip disk  
Gleitschutz Gummi Scheibe  
Platillo antideslizante con goma



08012AS54M

08012AS54N

### puntali

Art	ø mm
20PT TILT85N	85
☑ 100	



Art	Finitura/Finishing
20P M091	neutro/neutral
☑ 100	



Art	Finitura/Finishing
20PT 8X30	neutro/neutral
20PT 8X30N	nero/black
☑ 1000	

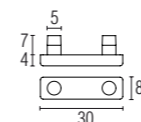

Art	Finitura/Finishing
20PT 485	neutro/neutral
20PT 485N	nero/black
☑ 100	

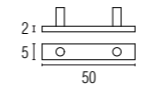

Art	ø mm
20PT E9 25BN50	50
☑ 100	

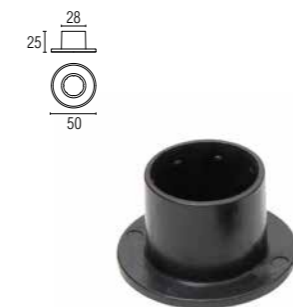

Art	Finitura/Finishing
20PT 8X201	neutro/neutral
☑ 100	

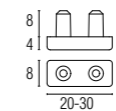

Art	Finitura/Finishing
20PT NICK	neutro/neutral
☑ 100	

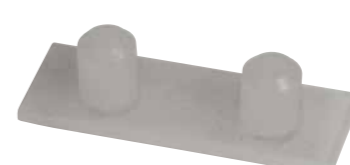
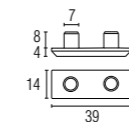

Art	Finitura/Finishing
20PT 608	neutro/neutral
☑ 1000	

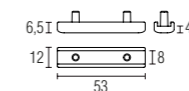

Art	Finitura/Finishing
20PT LINCEN	trasparente/transparent
20PT LINCEN	nero/black
☑ 100	

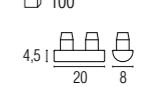

Art	Finitura/Finishing
20PT LAIKAT	trasparente/transparent
20PT 2414 8X30T	trasparente/transparent
☑ 100	

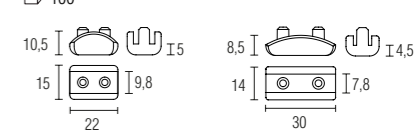

Art	Finitura/Finishing
20PT P2P	neutro/neutral
20PT P2PN	nero/black
☑ 100	

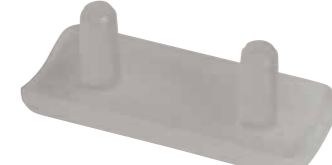
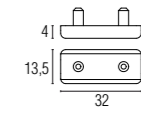

Art	Finitura/Finishing
20PT MARTIN	neutro/neutral
☑ 1000	

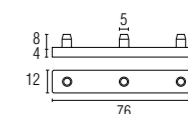

### puntali

Art	Finitura/Finishing
<b>20P A2N</b>	trasparente/transparent
☐ 100	

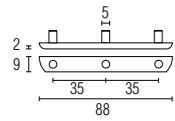

Art	Finitura/Finishing
<b>20PT MARYT</b>	neutro/neutral
☐ 1000	

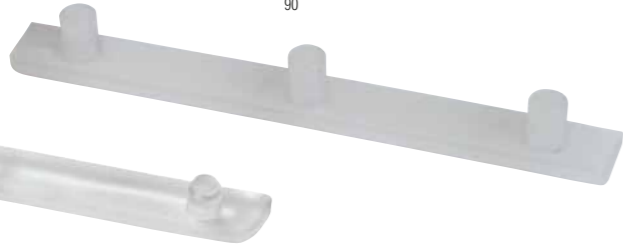
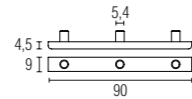

Art	Finitura/Finishing
<b>20PT ZOE</b>	neutro/neutral
☐ 100	

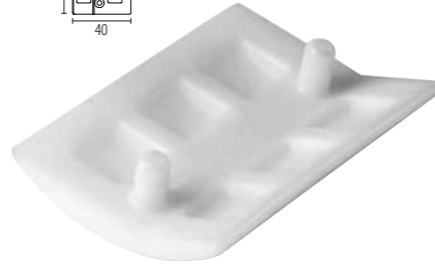
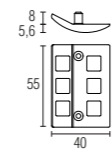

Art	Finitura/Finishing
<b>20PT ZOT55X55</b>	neutro/neutral
☐ 100	

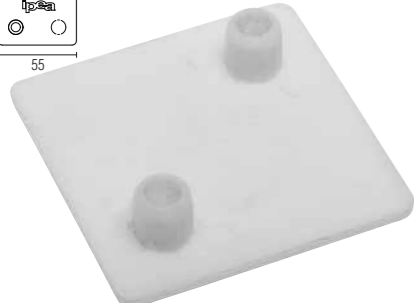
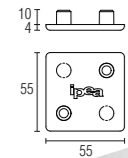

Art	Finitura/Finishing
<b>20PT PD007</b>	neutro/neutral
<b>20PT PD007N</b>	nero/black
☐ 1000	

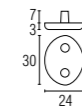

Art	Finitura/Finishing
<b>20PT SMERALDO</b>	nero/black
☐ 100	

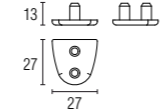

Art	Finitura/Finishing
<b>20PT RIGOLETTO</b>	nero/black
☐ 100	

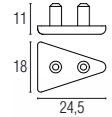

Art	Finitura/Finishing
<b>20P T009</b>	neutro/neutral
<b>20P T009/07</b>	testa di moro/brown
☐ 100	

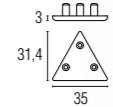

Art	Finitura/Finishing
<b>20PT ASTICO</b>	neutro/neutral
☐ 100	

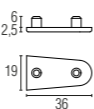

Art	Finitura/Finishing
<b>20PT 40X10G</b>	grigio/gray
<b>20PT 40X10N</b>	nero/black
☐ 100	

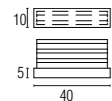

Art	Finitura/Finishing
<b>20PT ANGELOFES</b>	nero/black
☐ 100	



Art	Finitura/Finishing
<b>20PT 50X50F</b>	nero/black
☐ 100	

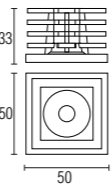

### puntali

Art	Finitura/Finishing
<b>20PT SWAN</b>	nero/black
☐ 100	

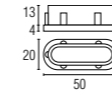

Art	Finitura/Finishing
<b>20PT OLI</b>	nero/black
☐ 100	

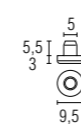

Art	Finitura/Finishing
<b>20PT META</b>	neutro/neutral
☐ 100	



Art	Finitura/Finishing
<b>20PT SPACER</b>	neutro/neutral
☐ 100	

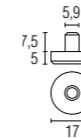

Art	Ø mm	Finitura/Finishing
<b>20PT 20</b>	20	nero/black
<b>20PT 20T</b>	20	neutro/neutral
<b>20PT 30</b>	25	nero/black
<b>20PT 25</b>	30	nero/black
<b>20PT 40</b>	40	neutro/neutral
<b>20PT 40N</b>	40	nero/black
<b>20PT 45</b>	45	nero/black
☐ 1000		

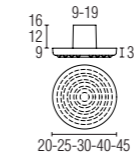

Art	Finitura/Finishing
<b>20PT JD11</b>	neutro/neutral
☐ 100	



Art	Finitura/Finishing
<b>20PT SHELLY</b>	trasparente/transparent
☐ 100	



Art	Finitura/Finishing
<b>20PT BUNNY</b>	neutro/neutral
☐ 100	



Art	Finitura/Finishing
<b>20PT PF120X8N</b>	nero/black
☐ 100	



Art	Finitura/Finishing
<b>20PT TRASP</b>	trasparente/transparent
<b>20PT TRASPN</b>	nero/black
☐ 100	

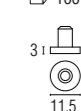

Art	Finitura/Finishing
<b>20PT ANG</b>	neutro/neutral
☐ 100	

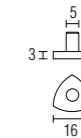

Art	Finitura/Finishing
<b>20PT SMILE</b>	trasparente/transparent
☐ 100	

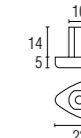



## Condizioni generali di vendita

### 1. Ordinazione

L'ordinazione implica accettazione delle presenti condizioni generali di vendita alle quali non è ammessa deroga, se non espressamente convenuto per iscritto. Gli ordini passati ad ausiliari ed intermediari del commercio vengono assunti salvo approvazione della casa.

### 2. Prezzi

I prezzi si intendono franco fabbrica "Ipea srl" salvo diversa intesa scritta. I prezzi dei prodotti della "Ipea srl" sono quelli esposti nei suoi listini in vigore o nelle sue offerte e potranno però essere variati in qualsiasi momento ed entreranno in vigore alla data stessa in cui verranno fissati.

### 3. Pagamenti

La consegna della merce non trasferisce la proprietà della stessa se non a pagamento integralmente avvenuto. Ogni spedizione è considerata indipendente dalle altre agli effetti del pagamento. Il ritardo dei pagamenti o qualsiasi altra inadempienza ci dà diritto alla sospensione di ogni ulteriore fornitura. Qualunque contestazione sorgesse dalle parti, anche relativa alle garanzie consentite ed accettate non porterà alcun prolungamento nei termini di pagamenti convenuti, né il diritto di sospenderli, o comunque di modificarli e qualsiasi esecuzione del compratore non potrà essere ritenuta procedibile se lo stesso non proverà di essere in regola con i pagamenti.

### 4. Imballo

L'imballaggio del materiale viene addebitato al puro costo salvo diversa intesa concordata o scritta.

### 5. Consegna

La consegna della merce si intende sempre franco nostra fabbrica salvo diversa intesa scritta. I termini di consegna vengono indicati al compratore a puro titolo indicativo e decorrono dalla data di conferma dell'ordinazione.

### 6. Spedizioni

Le spedizioni sono sempre eseguite per conto e a rischio del compratore anche se effettuate franco destino. In mancanza di istruzioni precise da parte del compratore esse verranno effettuate col mezzo ritenuto più opportuno dalla "Ipea srl".

### 7. Reclami e resi di materiale

Eventuali reclami devono essere denunciati entro 8 giorni dal ricevimento della merce. Non si accetta merce di ritorno senza preventiva autorizzazione della "Ipea srl".

### 8. Giurisdizione

Per qualsiasi contestazione in cui la "Ipea srl" sia convenuta è esclusivamente competente il Foro di Milano.

## Standard condition of sale

### 1. Orders

Orders imply the acceptance of these general terms of sale. No derogation of them shall be valid unless made in writing. Orders transmitted by our agents are in every case, subject to "Ipea srl" acceptance.

### 2. Prices

Prices refer to products dispatched ex works from Ipea srl's premises. The price of the products shall be that which is included in the current price list and/or in the offer, but they can be modified with simultaneous effect, at any time.

### 3. Payments

The delivery of the goods does not imply ownership of the same till full payment has been made. In the case of a delay in payments, or any other non-fulfilment, we are authorised to suspend any other supplies. All disputes arising between parties, even those concerning guarantees agreed and accepted, neither imply any prolongation of the agreed terms of payment, nor the right to suspend them, nor in any case, modifying them. No execution of the buyer can be started if he cannot prove that he is fulfilling payment.

### 4. Packaging

The packaging will be debited at cost, unless there is any other verbal or written agreement.

### 5. Delivery

Delivery of the products will be made ex-works from "Ipea srl" premises, unless there are previous written agreements. Delivery terms are merely indicative and begin to be effective from the date of confirmation of the order.

### 6. Dispatches

Products are always dispatched on behalf of and at the buyer's risks, even in the case of freight / carriage paid to buyer's domicile. Unless there are specific instructions from the buyers products shall be dispatched by the method of transport chosen by "Ipea srl".

### 7. Complaints And sales returns

Complaints, if any have to be notified within 8 days of reception of goods. sales returns will not be accepted without previous consent from "Ipea srl"

### 8. Jurisdiction

The competent Milan Low Courts shall have jurisdiction in any action in which "Ipea srl" will be the defendant.

■ Gli articoli illustrati nel presente catalogo non comportano necessariamente l'obbligo di disponibilità e/o realizzazione.

■ Tutte le misure del presente catalogo sono espresse in mm e possono essere variate per esigenze tecniche senza preavviso.

■ Siamo certi comprenderete che non possiamo assumerci la responsabilità di un utilizzo improprio dei nostri articoli.

■ Prodotti soggetti alle condizioni di garanzia consultabili su [www.ipea.it/faq.php](http://www.ipea.it/faq.php)

■ The articles illustrated in this catalogue do not necessarily involve the availability and/or realization duty.

■ All the measurements in this catalogue are in mm and are subject to variation for technical reasons without forewarning.

■ We kindly ask for your understanding that we cannot take over any responsibility for improper application of our products.

■ Products subject to warranty conditions available for consultation at [www.ipea.it/faq.php](http://www.ipea.it/faq.php)

■ Die in diesem Katalog illustrierten Artikel sind nicht notgedrungen mit den Liefermöglichkeit und /oder Realisationspflicht verbunden.

■ Alle Masse in diesem Katalog sind in mm angegeben und Können aus technischen Gründen, ohne Vorankündigung, geändert werden.

■ Wir bitten um Verständnis, dass wir für unsachgemäße Verwendung unserer Produkte keine Haftung übernehmen.

■ Produkte unterliegen Garantiebedingungen, die auf der Website sind: [www.ipea.it/faq.php](http://www.ipea.it/faq.php)

■ Ipea no está obligada a garantizar la disponibilidad y/o la realización de los artículos presentados en este catalogo.

■ Todas las medidas del presente catalogo son en mm y pueden ser variadas por exigencias tecnicas sin previo aviso.

■ Estamos seguros que comprenderán que no podemos hacernos responsables por un uso inadecuado de nuestros artículos.

■ Productos sujetos a las condiciones de garantías indicadas en la web [www.ipea.it/faq.php](http://www.ipea.it/faq.php)